

宁波金羽桥照明科技有限公司
NINGBO KING-BRIDGE LIGHTING
TECHNOLOGY CO.,LTD.

地址：浙江省余姚市阳明街道新桥工业区
Add: Xinqiao Industry Zone, Yangming Street, Yuyao City,
Zhejiang Province, China
Tel: +86-574-6256 6890
Fax: +86-574-6256 6827
info@kled.com

国内营销中心:

金羽桥照明科技（上海）有限公司
地址：上海市长宁区中山西路179号4K室
电话：189 1897 7928

KLED
— King-Bridge Lighting —

**TG-221A Series
Flood Lighting**



KLED.com

TG-221A Series
A High Power LED Flood Lighting

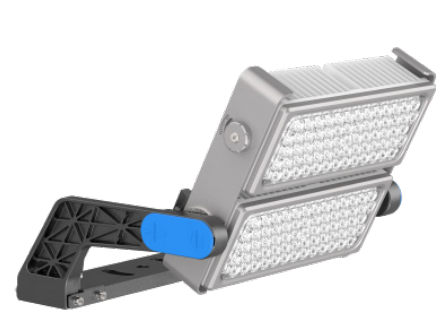

TG-221A-2M
400-500W



TG-221A-3M
600-750W



TG-221A-4M
800-1000W

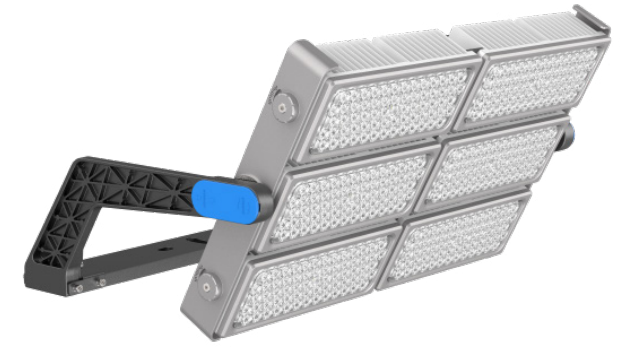

TG-221A-6M
1200-1500W



TG-221A Series

一款模块化并具有电视转播一致性指数 (TLCI) 的LED体育场照明灯具, 并提供多种光学系统, 能满足各类体育场地的照明需求。

A LED stadium lighting fixture with TLCI (Television Lighting Consistency Index) that surpasses similar products and provides a variety of optical systems to meet the lighting needs of various stadiums.



4 SIZES

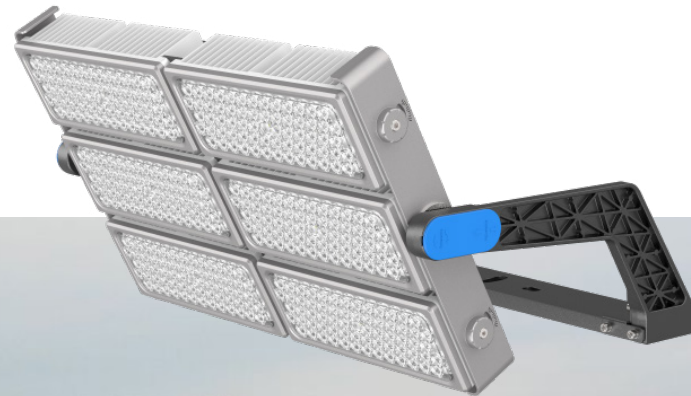

简述 Description

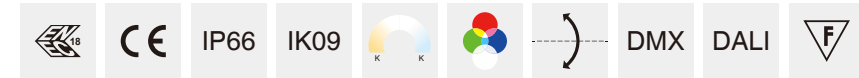

- 灯具散热器采用6063型材, 灯具电器箱和光源模组采用分离式独立结构
- 高效透镜光学设计, 具有高视觉舒适性和均匀配光透镜, 供多种不同配光选择
- 电器箱采用独特设计, 安全快捷开启, 整体防护IP66
- 防紫外线聚氨酯粉末喷涂表面, 盐雾测试可以达1000小时以上
- 无生物蓝光危害风险, 符合EN62471: 2008标准
- 所有外部螺钉均为304不锈钢材质



- The lighting radiator adopts 6063 profile, the electrical box and light adopt separate independent structure.
- Optics with lens design with high visual comfortable and uniform lighting distribution, multiple light distribution options.
- The electrical box adopts unique design, safe and fast opening, and the overall protection is IP66.
- Surface anti-ultraviolet pure polyester powder painting, Corrosion resistance can be more than 1000 hours.
- No photo-biological risk, (no risk linked to infrared, blue light and UV radiation) in accordance with EN 62471:2008.
- All external screws are made of 304 stainless steel.

抗振等级: 通过5G /15Hz /3轴各10万次振动测试
 风压测试: >72m/s
 功率: 400W-1500W
 光效: 140-160 Lm/W
 色温: 4000K / 5000K / 5700K
 显色指数: >70Ra / 80Ra / 90Ra
 功能选项: 0-10V / DALI / DMX / RGBW

Anti vibration grade: Passed 100K times vibration tests of 5G / 15Hz / 3 axis.
 Wind pressure test: >72m/s
 Power: 400W-1500W
 Nominal efficacy: 140-160 Lm/W
 CCT: 4000K / 5000K / 5700K
 CRI: >70Ra / 80Ra / 90Ra
 Options: 0-10V / DALI / DMX / RGBW

- 应用场合: 体育馆、港口码头、机场及大型建筑立面泛光照明
- Applications: Sport stadium, port, and larger building illumination.

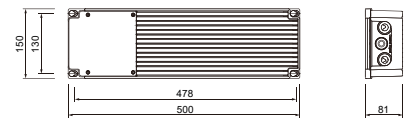

智能一体式驱动 Intelligent driver

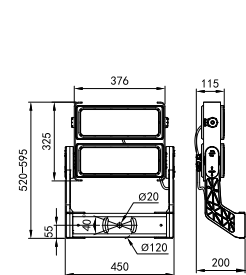

TG-221A-2M

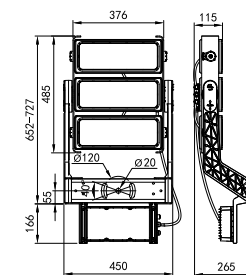

TG-221A-3M

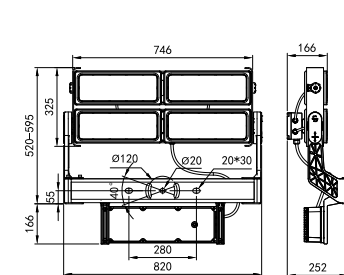

TG-221A-4M

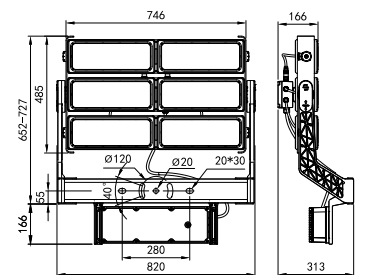

TG-221A-6M

不对称透镜 Asymmetric optics

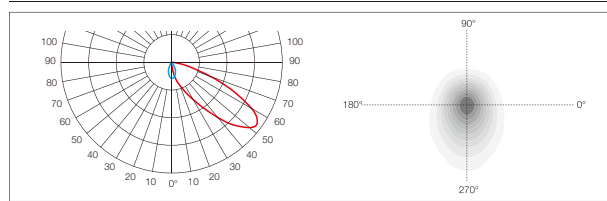

TM5A66
适用于运动场、广场、十字路口、停车场等区域照明
Asymmetrical Optic
For sports ground, square, intersection, parking and other areas.

LED Chips: 66 in 1

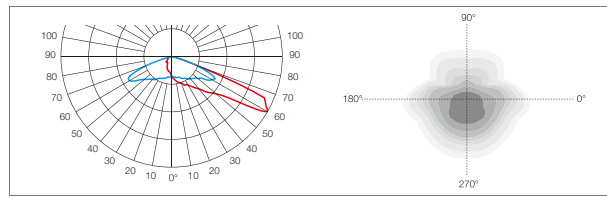

TM6A66
适用于运动场、广场、十字路口、停车场等区域照明
Asymmetrical Optic
For sports ground, square, intersection, parking and other areas.

LED Chips: 66 in 1

对称透镜 Symmetric optics

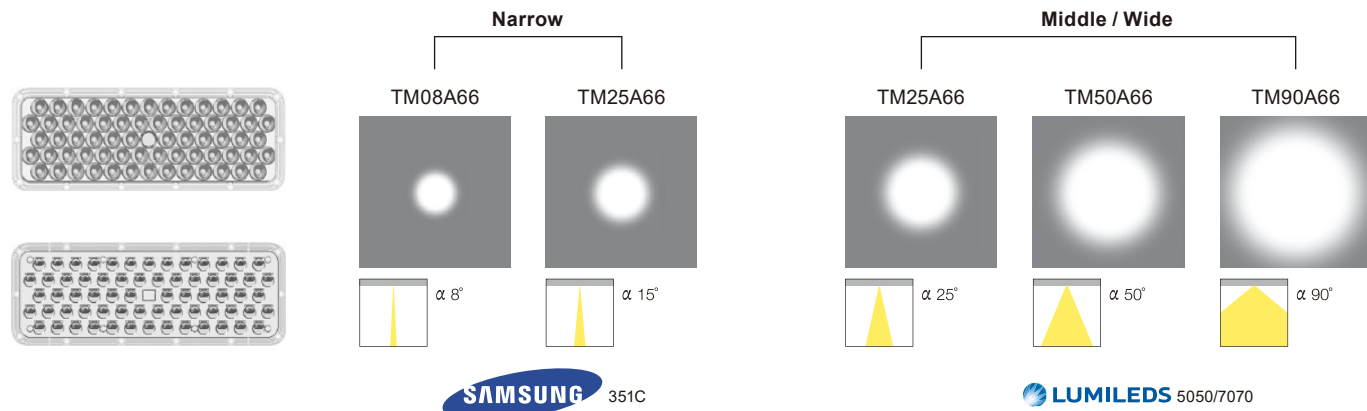

灯具颜色 Colour optics

灯珠颜色的变化可以提供丰富多彩的动画RGBW效果。可以点亮屋顶，突出立面，甚至创建定制的颜色图案的屋顶照明。观众将能够体验一个独特精彩的体育活动。

The change of lamp bead color can provide rich and colorful animation RGBW effects. it can light the roof, highlight the facade, and even create custom color pattern roof lighting. The audience will be able to enough to experience a unique and wonderful sports activity.

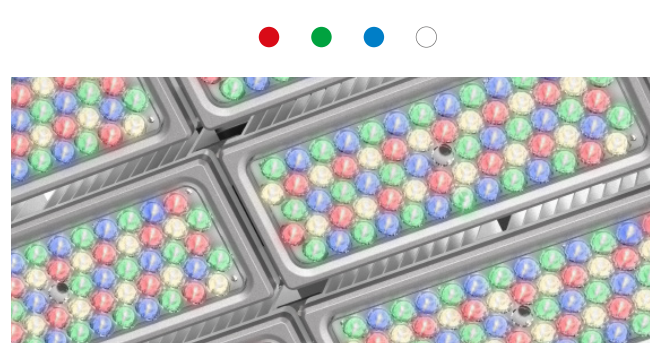

RGBW

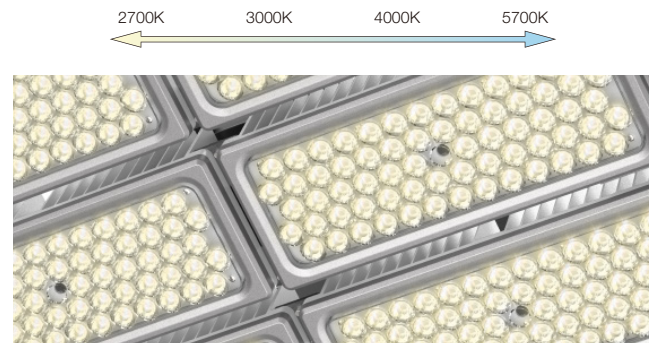

Balanced White

技术参数 Technology data



TG-221A-2M

Code	Power	LED Qty	Packing Size	Weight	Pcs/20"	Pcs/40"
LED chips - 3535/5050				Body:		
TG-221ALED400-2M	400W	132	465*425*180	11.5	756	1572
TG-221ALED500-2M	500W	132	465*425*180	11.5	756	1572



TG-221A-3M

Code	Power	LED Qty	Packing Size	Weight	Pcs/20"	Pcs/40"
LED chips - 3535/5050				Body:		
TG-221ALED600-3M	600W	198	685*480*250	14.5	270	568
TG-221ALED750-3M	750W	198	685*480*250	14.5	270	568

Remark:
Intelligent integrated driver:
Weight / Packing: 4.2kg / 487*487*170 / 2PCS

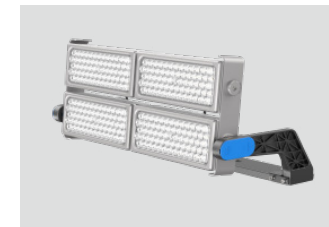

TG-221A-4M

Code	Power	LED Qty	Packing Size	Weight	Pcs/20"	Pcs/40"
LED chips - 3535/5050				Body:		
TG-221ALED800-4M	800W	264	840*430*200	19	246	520
TG-221ALED1000-4M	1000W	264	840*430*200	19	242	512

Remark:
Intelligent integrated driver:
Weight / Packing: 4.2kg / 487*487*170 / 2PCS(800W)
Weight / Packing: 5.5kg / 587*487*170 / 2PCS(1000W)



TG-221A-6M

Code	Power	LED Qty	Packing Size	Weight	Pcs/20"	Pcs/40"
LED chips - 3535/5050				Body:		
TG-221ALED1200-6M	1200W	396	840*695*250	25	189	405
TG-221ALED1500-6M	1500W	396	840*695*250	25	189	405

Remark:
Intelligent integrated driver:
Weight / Packing: 6.2kg / 587*487*170 / 2PCS

延伸产品 More in family

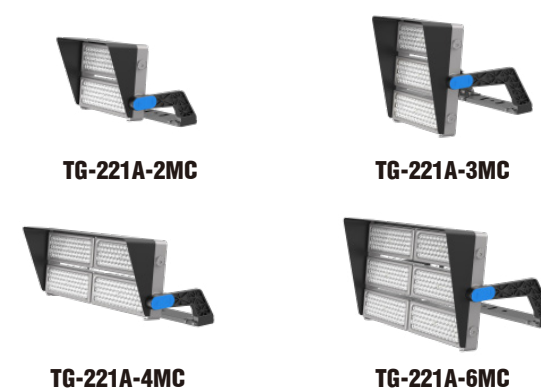

可选配件 Accessories options

	Code
防眩罩(2M) Visor (2M)	220004040
防眩罩(3M) Visor (3M)	220002832
防眩罩(4M) Visor (4M)	220002833
防眩罩(6M) Visor (6M)	220002834
Z形支架 Z-Shaped Bracket	220003850

设计亮点 Design highlight

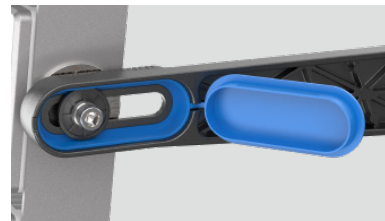

蓝色装饰盖可掀开调整灯具的左右距离和旋转角度

The blue decorative cover can be opened to adjust the left and right distance and rotation angle of the lamp

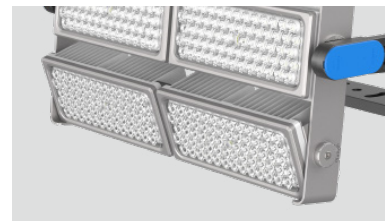

单模组可调，满足更多照明需求

Single module can be adjusted to meet more lighting needs

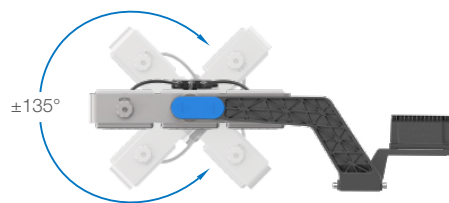

±135°任意角度调节
±135°Beam angle rotatable

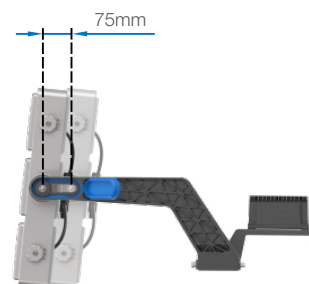

模组位置进出可以调节75mm
The modular position can be retraced 75mm for in or out



专业驱动 Professional driver

智能一体式驱动
Intelligent integrated driver

无论是大型体育场、娱乐场还是区域性照明，紧凑型专业驱动在所有类型的安装中都能提供便捷和卓越的性能。

Whether large stadiums, casinos or area illumination compact special lighting driver can provide high performance and more convenient in all of installations.

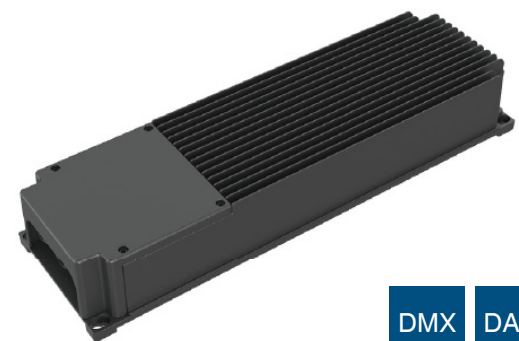

DMX DALI

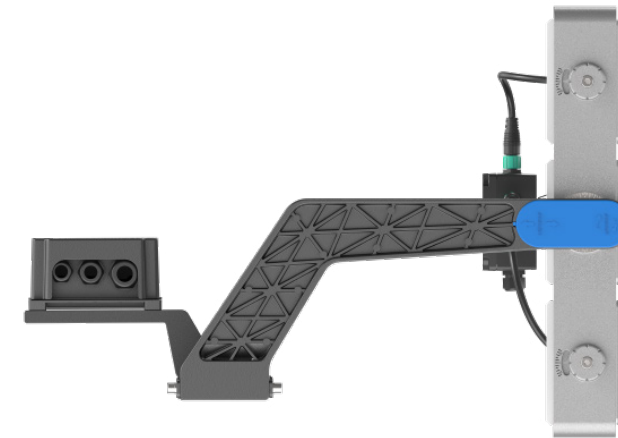

灵活直观的设计
Flexible and intuitive design

此款灯具配有手把，提拿安装更方便。角度调整使用刻度盘很简单，可以快速精确地对准，满足多种照明需求，使用更加得心应手。

This luminaire is equipped with handle, which is more convenient to carry and install. The measuring disk is very simple to use and can rapid and accurate alignment can meet a variety of lighting needs and make it easier to use.

精准光学组件 + 精准瞄准器
Multiple optical options
+ Aiming sight

灯具具有多种光学透镜选项，安装时通过瞄准器精准控制光的投射位置。

The luminaire has multiple optical options, When installing the luminaire, it can accurately adjust the projection angle through the aiming sight advice .

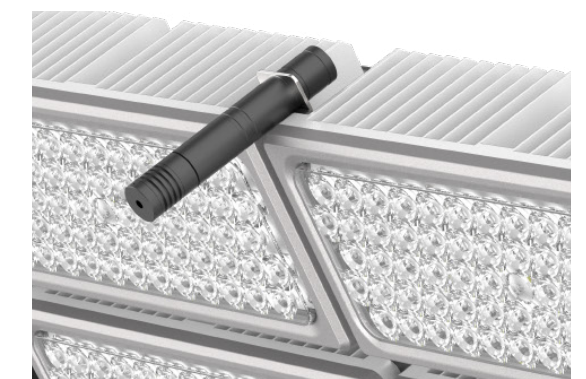

模组化设计 + 快速插拔自锁接头
Modular design
+ Quick-Plug connector

此款灯具采用模组化设计，降低了维护成本，模组之间设有增强空气对流的通道，可以加强灯具散热、降低热量聚集。灯具背部采用快速插拔电缆连接设计，满足客户快捷安装维护要求。

The modular design of this lamp reduces the maintenance cost. There is a channel to enhance air convection between the modules, which means that the heat dissipation of the luminaire can be strengthened and the heat accumulation can be reduced. quick-plug cable connected design, it can meet the customers for quickly installation and maintenance requirements.