

宁波金羽桥照明科技有限公司
NINGBO KING-BRIDGE LIGHTING
TECHNOLOGY CO.,LTD.

地址：浙江省余姚市阳明街道新桥工业区
Add: Xinqiao Industry Zone, Yangming Street, Yuyao City,
Zhejiang Province, China
Tel: +86-574-6256 6890
Fax: +86-574-6256 6827
info@kled.com

国内营销中心:

金羽桥照明科技（上海）有限公司
地址：上海市长宁区中山西路179号4K室
电话：189 1897 7928

KLED
— King-Bridge Lighting —

T-103 Series Smart Column Lighting



KLED.com

SMART T-103 Series COLUMN LIGHTING



▲ 庭院灯
LIGHT
T-103LED50-H450

▲ 庭院灯+摄像头LIGHT
+CAMERA
T-103CALED50-H450

▲ 庭院灯+音响
LIGHT+SPEAKER
T-103SLED50-H450

▲ 庭院灯+无线网络
LIGHT+WIFI
T-103WLED50-H450

▲ 庭院灯+充电桩
LIGHT+EV CHARGING
TC-103LED50-H450

▲ 太阳能庭院灯
SOLAR LIGHTING
TS-103LED50-H450



一体式智慧庭院灯
All-in-One Integrated Smart Column Lighting



一款智能化的柱形景观灯，使用包含预认证硬件的即插即用可旋转模块，可以根据您的特定需求进行配置。

A smart column lighting is a connected, modular approach to city hardware. With plug-and-play rotatable modules that contain pre-certified hardware, it can be configured to suit your specific needs.



T-103SM
 30-50W

- 铝压铸上盖和铝合金型材灯柱，根据需要切割成不同灯杆高度，PC透明塑料罩
- 防眩透镜，具有高视觉舒适性和均匀配光透镜
- 驱动有0-10V / DALI / 编程电源选择，20KV浪涌保护器
- 模块式电器部件，安装更换方便
- 防紫外线聚氨酯塑料喷涂表面，盐雾测试可以达1000小时以上
- 无生物蓝光危害风险，符合EN62471: 2008标准
- 道路灯智能远程控制系统可选，可以与远程管理系统兼容
- 所有外部螺钉均为304不锈钢材质
- Die-casting aluminium top cover, extruded aluminium column pole, the height according to the client required, PC transparent diffuser.
- Anti-glare lens with high visual comfortable and uniform lighting distribution.
- High quality LED chips, Driver with 0-10V/DALI/programmed options, and with surge protection up to 20KV.
- LED module is used inside, integrated electrical components which is easy to install and replace.
- Surface anti-ultraviolet pure polyester powder painting, Corrosion resistance can be more than 1000 hours.
- No photo-biological risk, (no risk linked to infrared, blue light and UV radiation) in accordance with EN 62471:2008.
- Street lighting control used with smart control technology, compatible with remote management system.
- All external screws are made of 304 stainless steel.

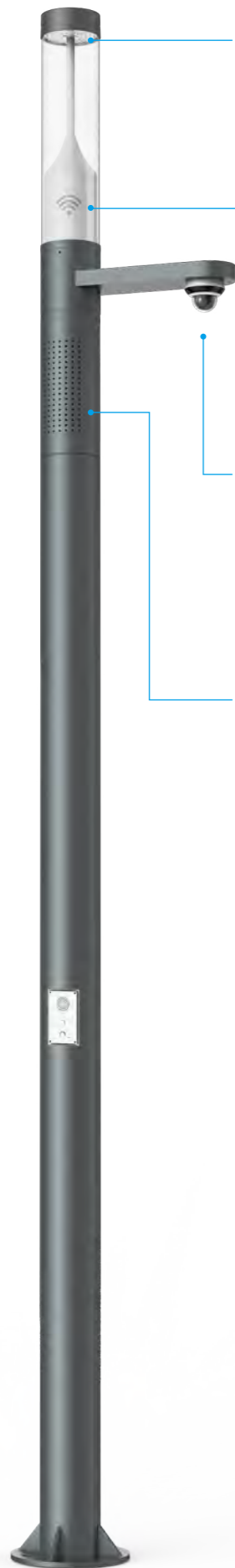

- 

智能LED模组
INTELLIGENT LED MODULE 50W
Warm or neutral white LEDs
Optional internal diffuser or external diffuse protector for enhanced visual comfort
- 

无线网络
WIRELESS INTERNET
Providing 4G / 5G capacity and coverage
Wireless fibre communication network for smart city applications
- 

安防监控
SAFETY CAMERA
Professional camera networks
Integrated 360-degree video CCTV solution
- 

智能音箱
LOUDSPEAKER
Professional sound system for public service announcements, warnings and music

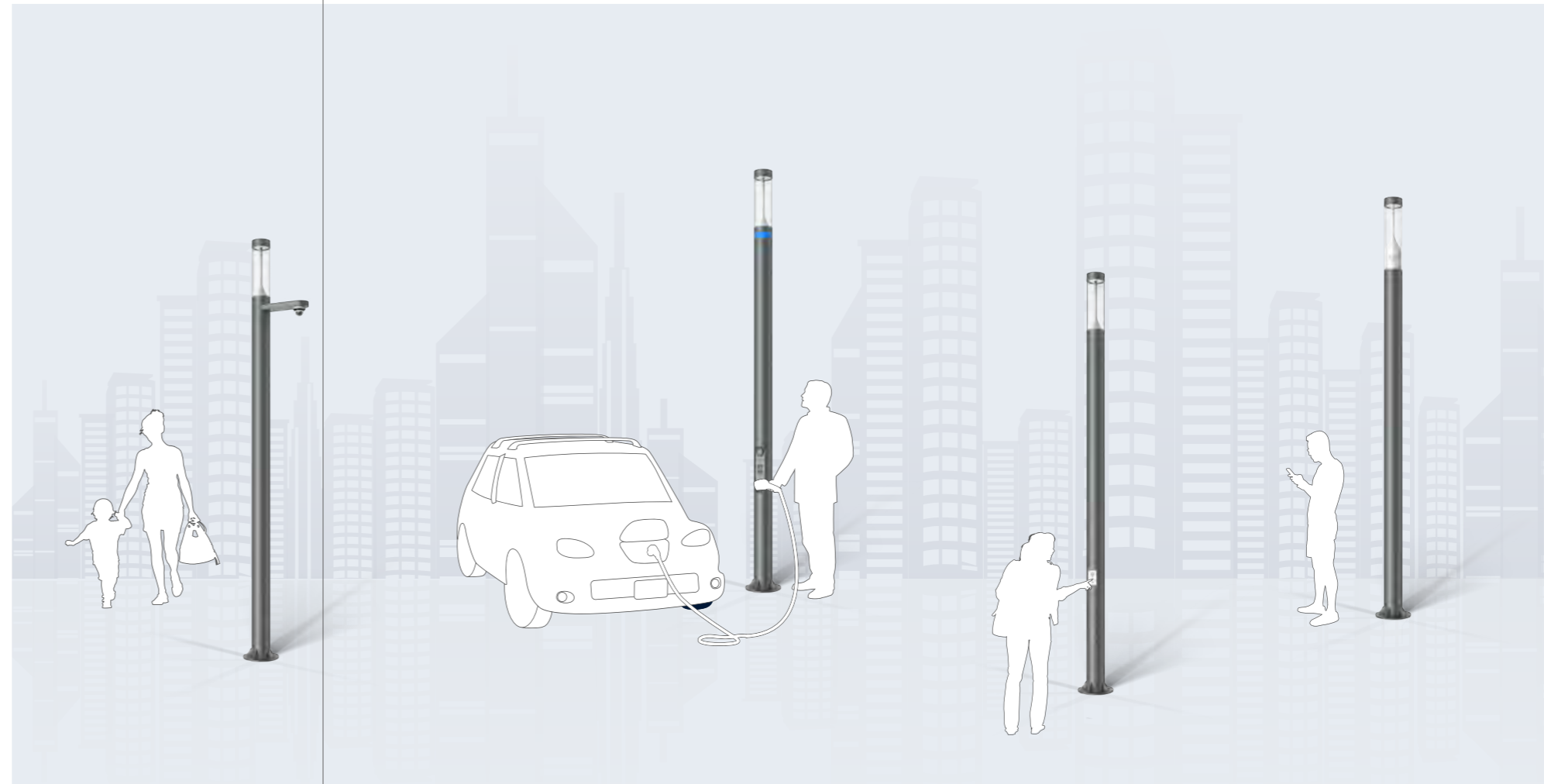

SOS 一键报警
SOS
One-touch system to contact operators and/or to trigger panic response scenarios

 **电源插座**
POWER SUPPLY
Auxiliary power source
Integrated fuse

 **LED屏**
LED SCREEN
Suitable for advertising
Create atmosphere

 **充电桩**
EV CHARGING
Professional charging station
Safety locking during charging



WLAN

专业、安全的无线网络
Professional and Secure Wireless Network

- 可提供360°照明模块或专用模块
- 每个接入点有多个并发用户
- 以更高的数据速率稳定连接
- 可分割宽带：例如为城市运营商分配专用部分，为普通公众分配有限宽带
- Available in a 360° lighting module or in a dedicated module
- Multiple concurrent users per access point
- Stable connections at higher data rates
- Dividable bandwidth: e.g. to assign a dedicated part to city operators and a restricted bandwidth for the general public

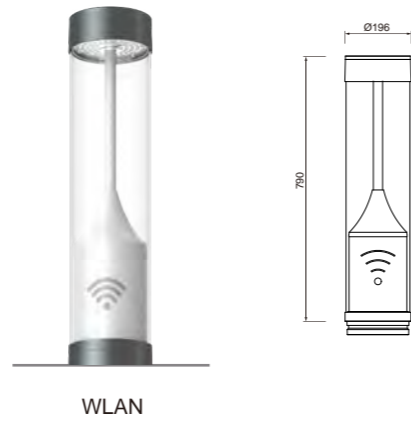

WLAN



WIRELESS BACKHAUL

用于智慧城市应用的无线光纤通信网络
Wireless Fibre Communication Network For Smart City Applications

- 与电线杆之间的无线扩展光纤连接
- 光纤的速度（高达2.3Gbps），无线的灵活性
- 简单的街道级部署
- 可靠、几乎无干扰的操作
- 从一个基本单元连接多达8个Shuffle
- 400米自动对准距离
- AES加密算法
- 工作于60GHz V波段

- Wireless extended fibre connections to and from a pole
- The speed of fibre (up to 2.3Gbps), the flexibility of wireless
- Easy street level deployment
- Reliable, virtually interference-free operations
- Connect up to 8 Shuffles from one Base Unit
- 400m auto-aligned range
- AES encryption
- Operates in 60GHz V band

1 Building to T-103W (star mode)

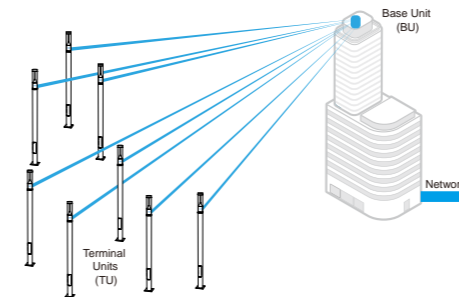

基本单元安装在室外，建筑物的侧面或屋顶上。它连接到安装在最大400米范围内的8个终端单元。
 The Base Unit is mounted outdoors, on the side of a building or on a rooftop. It connects to 8 T-103Ws (Terminal Units) installed within a range of 400 metres max.

2 T-103W to T-103Ws (star mode)

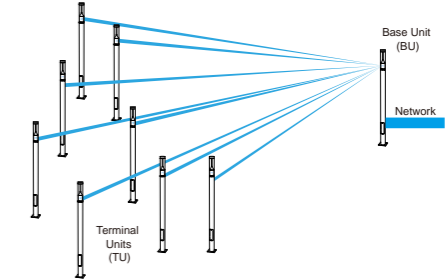

基本单元集成在一个T-103W中。这一个连接到安装在一个最大400米范围内的8个T-103W(终端单元)。
 The Base Unit is integrated in a SHUFFLE. This one connects to 8 T-103W(Terminal Units) installed within a range of 400 metres max.

3 Building to T-103W (linear mode)

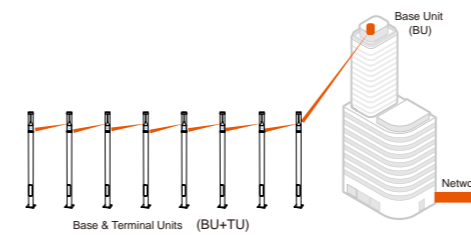

基本单元安装在室外，建筑物的侧面或屋顶上。它连接到一个T-103W(基本和终端单元)，该单元本身连接到另一个具有相同硬件的T-103W(BU+TU)以此类推，以菊花链布局。两个T-103W之间的间距可达400米(最大)。
 The Base Unit is mounted outdoors, on the side of a building or on a rooftop. It connects to one SHUFFLE (Base and Terminal Units) that itself connects to another SHUFFLE having the same hardware (BU+TU) and so on, in a daisy chain layout. The spacing between two SHUFFLES can be up to 400 metres (max).

The Base Unit is mounted outdoors, on the side of a building or on a rooftop. It connects to one SHUFFLE (Base and Terminal Units) that itself connects to another SHUFFLE having the same hardware (BU+TU) and so on, in a daisy chain layout. The spacing between two SHUFFLES can be up to 400 metres (max).

4 T-103W to T-103Ws (linear mode)

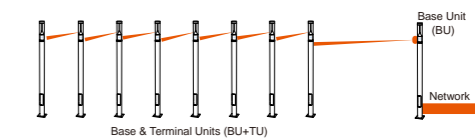

基本单元集成在一个T-103W中。它连接到一个T-103W(基本和终端单元)，该单元本身连接到另一个具有相同硬件的T-103W(BU+TU)以此类推，以菊花链布局。两个T-103W之间的间距可达400米(最大)。
 The Base Unit is integrated in a SHUFFLE. It connects to one SHUFFLE (Base and Terminal Units) that itself connects to another SHUFFLE having the same hardware (BU+TU) and so on, in a daisy chain layout. The spacing between two SHUFFLES can be up to 400 metres (max).

The Base Unit is integrated in a SHUFFLE. It connects to one SHUFFLE (Base and Terminal Units) that itself connects to another SHUFFLE having the same hardware (BU+TU) and so on, in a daisy chain layout. The spacing between two SHUFFLES can be up to 400 metres (max).

LIGHTING

360°灯光照明
360°lighting

街道照明 / 环境照明 / 人行横道照明
Street lighting / Ambiance lighting/Pedestrian crossing lighting

- 流明: 4500-8250lm
 - 背光控制(可选)
 - 暖色或中性白色LED
 - 可选不同灯头, 满足不同照明需求
- Lumen package range: from 4,500 to 8,250lm
 - Back light control (optional)
 - Warm or neutral white LEDs
 - Different lamp holders can be selected to meet different lighting needs

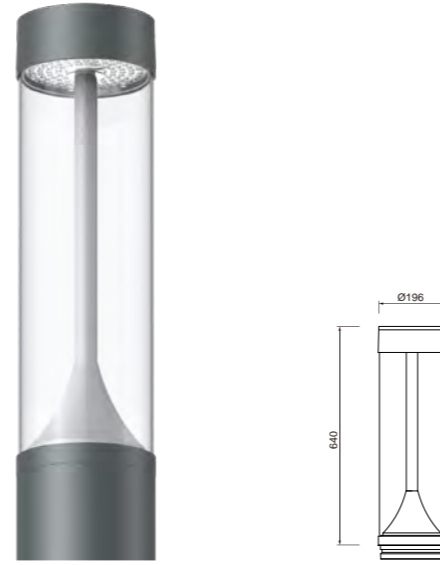

应用透镜 Optics application

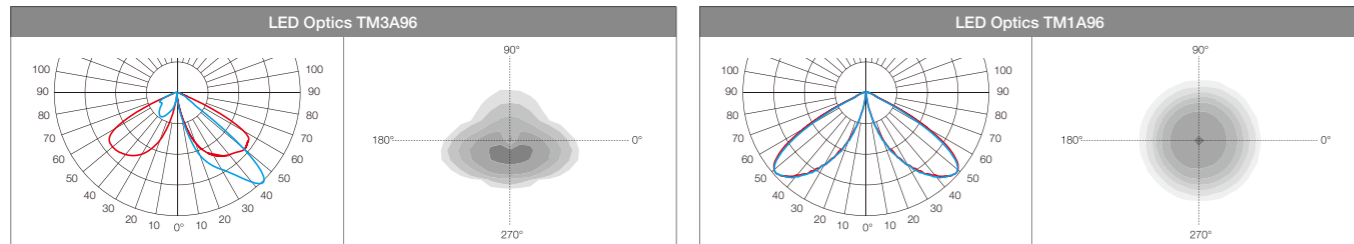

技术参数 Technology data



T-103

Code	Power	LED Qty	Optics	Lumious	Weight	Pcs/20'	Pcs/40'
LED chips - 3030							
T-103LED30-96H400	30W	96	TM3A96/TM1A96	4500-4950lm	Head: 7 Pole: 30	36	108
T-103LED50-96H500	50W	96	TM3A96/TM1A96	7500-8250lm	Head: 7 Pole: 38	36	72



EV CHARGING

电动汽车充电器
EV Charger

- 最大功率容量-智能软件确保每辆车的最佳充电量
- 灵活的支付/使用方式, 包括即插即用, 移动应用或RFID控制的充电
- 与任何符合OCPP标准的电动汽车软件供应商合作, 提供交钥匙电动汽车充电解决方案

- Maximised power capacity - intelligent software ensures the optimum amount of charge to each vehicle
- Flexible payment/usage methods including plug & charge, mobile app or RFID controlled charging
- Partnership with any OCPP compliant EV software providers to deliver turnkey EV charging solutions



Light Ring

光圈
Light Ring

标识 / 美化(身份) / 营造氛围
Signage / Beautification (identity) / Creation of ambiance

- 静态红色、绿色、黄色变化
 - 一个静态颜色
 - RGB变色效果
- Static red, green, yellow variants
 - 1 static colours
 - RGB for colour changing effects

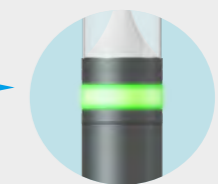
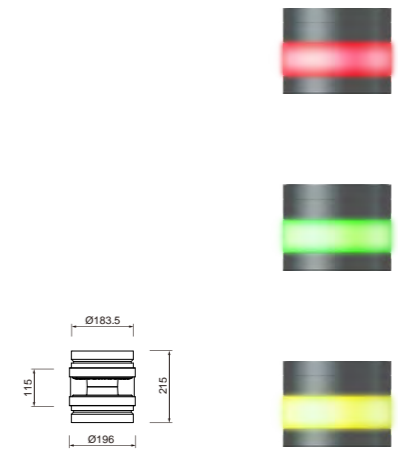

充电状态指示

颜色的变化可以指示充电桩
在使用过程中是充电状态,
还是充电完成状态

Charge Status Indication

The change of color can indicate
whether the charging pile is in a
charging state during use or a
charging completion state.

SPEAKER

公共服务公告、警告和音乐的专业音响系统
Professional Sound System For Public Service Announcements, Warnings And Music

- 专业一体化设计，密封性好
- 支持广播系统升级终端的远程固件，减轻维护人员的工作强度
- 完美的声音-高达25W的功率输出
- 防风雨/适用于室内和室外
- 数字连接网络扬声器

- Professional integrated design, good sealing
- Support the broadcast system to upgrade the remote firmware of the terminal, reducing the work intensity of maintenance personnel
- Perfect sound - up to 25W power output
- Weatherproof / adapted to indoor and outdoor applications
- Digital connected network speaker

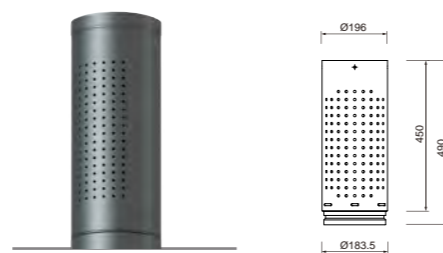

数字扬声器
Digital Speaker

频率范围 Frequency range	130 - 16000Hz
音频模式 Audio Format	16位CD音质 16-bit CD sound quality
工作温度 Operating Temperature	-20℃~60℃
IP等级 IP Level	IP54
功耗 Power Supply	≤30W

HORN

强有力的警告或警示
Warning or alarm with a powerful electronic tone

- 警告或警告附近居民
- 支持IP语音
- 多音高达105dB
- 可以远程触发
- 可以集成到一个全球预警系统
- 可连接至T-103对讲系统

- Warning or alert to the nearby population
- Supports voice-over IP
- Multi-tone up to 105dB
- Can be triggered remotely
- Can be integrated into a global warning system
- Can be linked to SHUFFLE Intercom



INTERCOM SOS

一键系统操作/触发紧急反应场景
One-touch system to contact operators and/or to trigger panic response scenarios

- 支持无服务器情况下的脱机对讲(发起和接收)
- 配备了1080P高清摄像头、电源输入接口、报警输入输出、录音输出等端口
- 支持免提通话、接收广播、实况监听等功能

- RSupport offline intercom (initiating and receiving) without server.
- Equipped with 1080P HD camera, power input interface, alarm input and output, recording output and other ports.
- Supports hands-free calls, broadcast reception, and live monitoring.



带摄像头的对讲系统
Intercom with cameras

摄像机 Camera	固定镜头1080P高清 Fixed lens 1080P
频率响应 Frequency Response	20Hz-18 kHz
播音员 S/N(Broadcast-Speaker)	≥81dB
功耗 Power consumption	≤ 4W
防护等级: Peak Transmit Power	IPX5



CCTV - 360°



四面视角
QuadView

360°可视闭路电视解决方案

Integrated 360-degree video CCTV solution

- 200万像素分辨率的高质量成像
- 采用由DarkFighter供电的技术，实现出色的低光性能
- 10倍光学变焦和16倍数码变焦提供广阔区域的近距离视图
- 高达50米的红外范围确保夜间安全
- 支持人脸捕捉，检测、捕捉、分级和选择运动中的人脸，并输出最佳人脸图片
- 防水防尘(IP66)

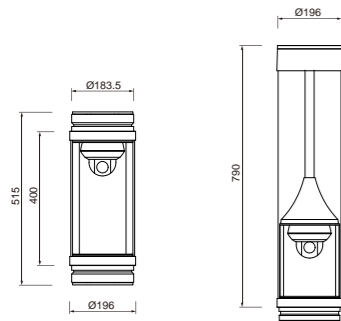

360°摄像头

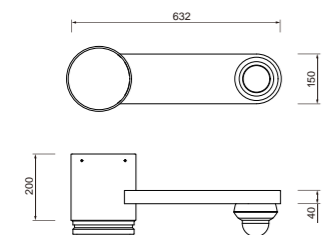

通用摄像头



通用型摄像头
Universal camera

一体化摄像头悬挂支架

Integrated hanging bracket for cameras

- High quality imaging with 2 MP resolution
- Excellent low-light performance with powered-by-DarkFighter technology
- 10x optical zoom and 16x digital zoom provide close up views over an expansive area
- Up to 50 m IR range ensures safety at night
- Supports face capture, detects, captures, grades and selects faces in motion, and outputs the best face picture
- Water and dust resistant (IP66)



More in Family

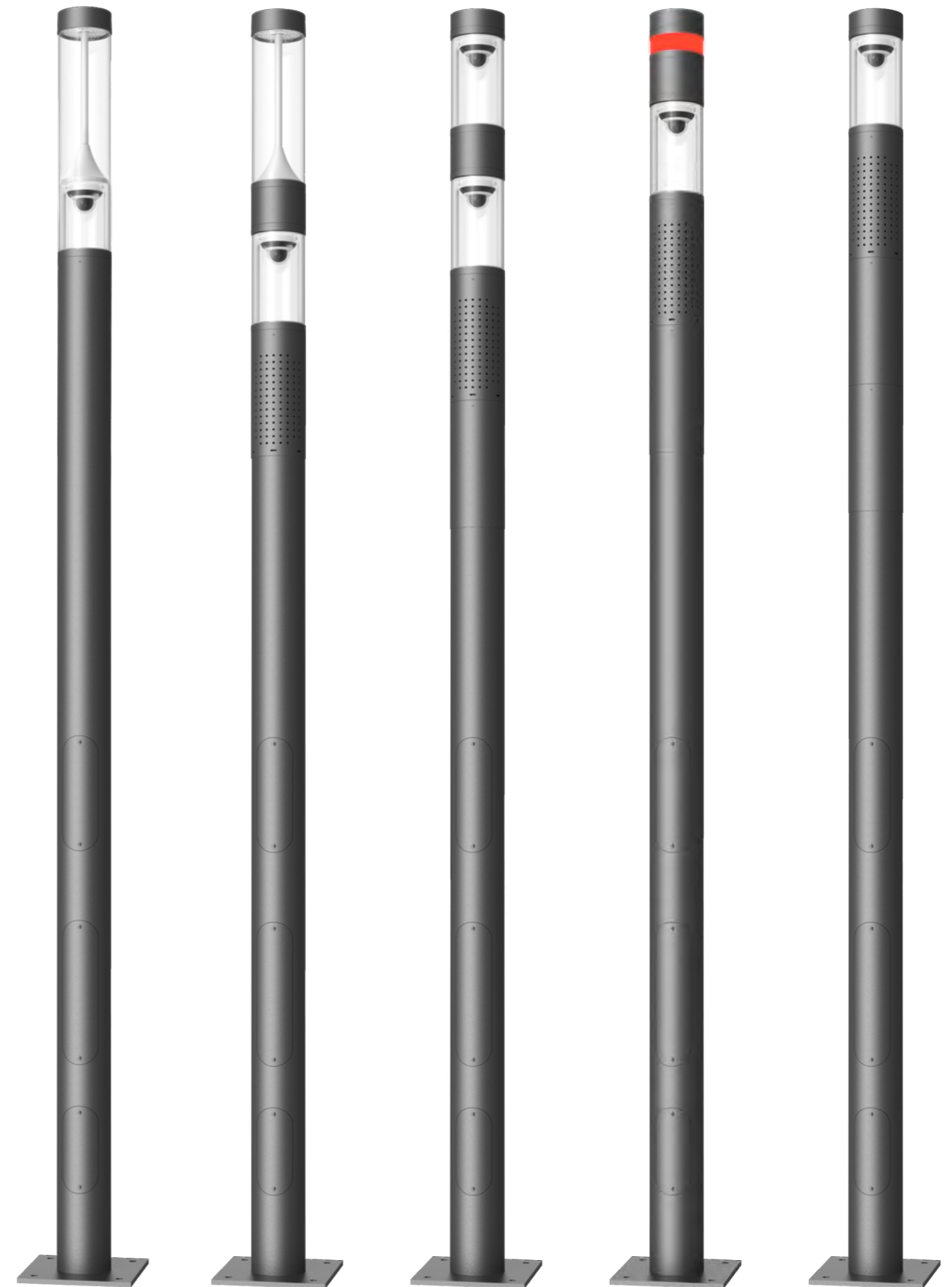

T-103CBLED50-H450

T-103CBSLED50-H450

T-103CB2S-H450

T-103LCBS-H450

T-103CBS-H450

CCTV - 180°

适用于专业摄像机网络

For professional camera networks

- 分辨率:全高清(1920x1080)
 - 出色的真彩色低光性能和低噪声, 适用于夜间应用
 - 内置红外LED, 可在0勒克斯条件下产生清晰的单色图像, 照射距离为15米(49英尺)
 - 事件触发:运动检测、视频分析、篡改等。
 - 新的“智能面部编码”为主要捕捉面部的ID相机应用增加了更多的带宽缩减
 - 环保耐用性:IP66,IK10
-
- Resolution: full HD (1920 x 1080)
 - Outstanding low light performance in true colour with low noise for night time applications
 - Built-in IR LED to produce a clear monochrome image in 0 lux conditions with 15m(49 feet) irradiation distance
 - Event triggering: motion detection, video analytics, tampering, etc.
 - New “Smart Facial Coding” adds more bandwidth reduction for ID camera applications mainly capturing faces
 - Environmental durability: IP66,IK10

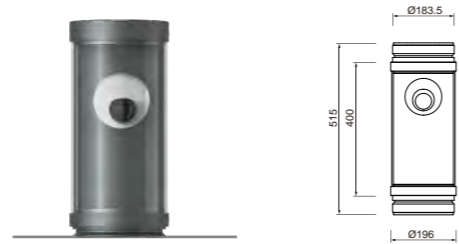

智能功能 Smart features	Yes
安全功能 Security features	全加密
红外距离 IR	15m



More in Family

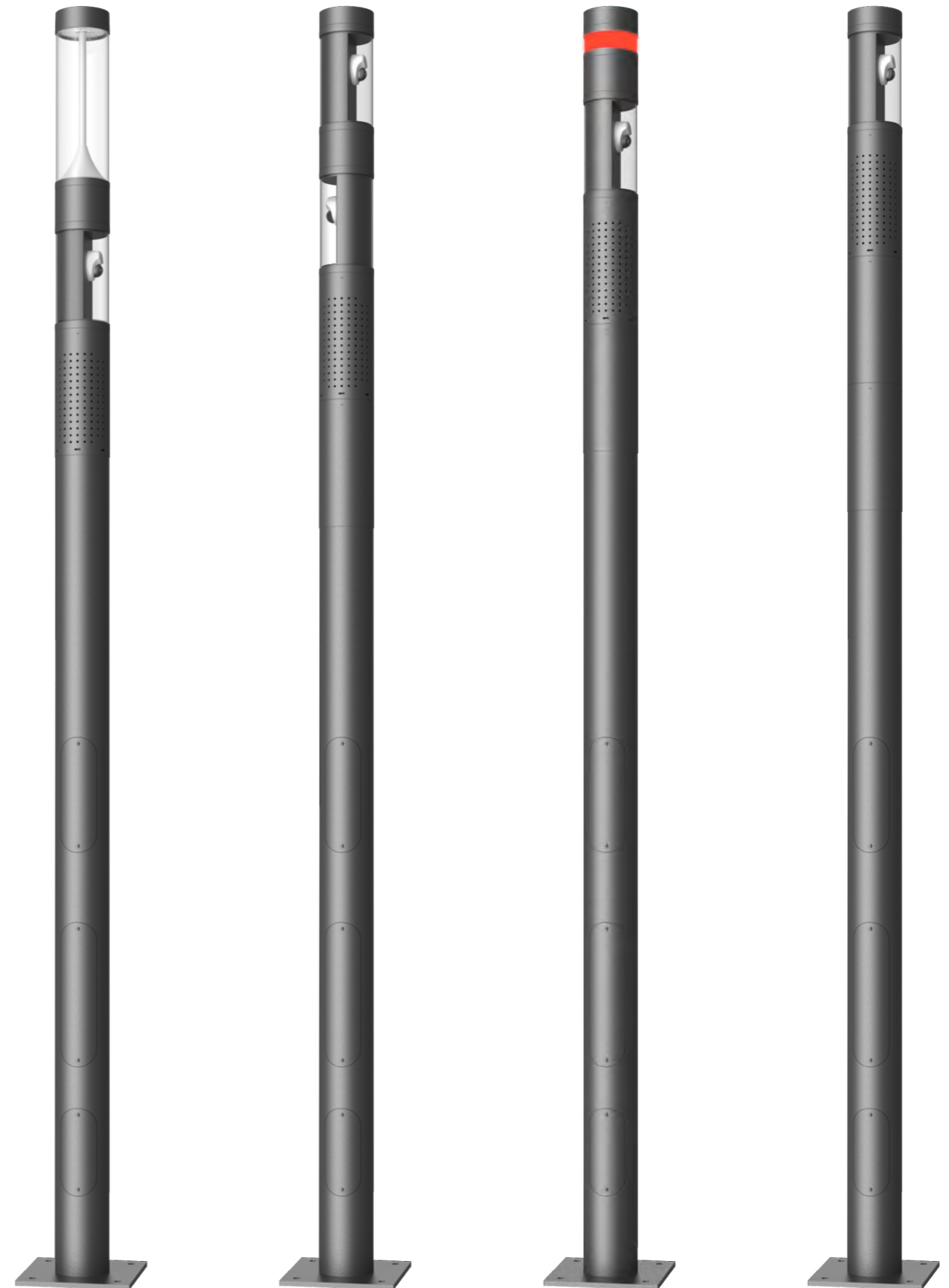

T-103CCSLED50-H450

T-103CC2S-H450

T-103LCCS-H450

T-103CCS-H450



SCREEN

LED 单面灯杆屏
LED single side pole screen

- 分辨率: 128*256/dot
 - 根据外部环境自动调节亮度, 节能, 减少光污染
 - 内置音柱: 底部内置IP音柱, 可实现远程实时互动功能
 - 超薄超清箱体结构, 箱体材质为镀锌材料, 窄边设计
 - 鲜艳的色彩, 吸引行人的目光, 起到很好的宣传效果
 - 通过它们, 城市变得更加生动活泼, 为市民的生活增添了一抹亮色
 - 智能温控散热, 同步无延时切换画面
 - 环保耐用性:IP65
-
- Resolution: 128*256/dot
 - Automatically adjust the brightness according to the external environment, saving energy and reducing light pollution.
 - Built-in sound column: Built-in IP sound column at the bottom, which can realize remote real-time interaction function.
 - Super thin super clean box structure, box material is galvanized material, narrow edge design.
 - Bright colors attract the eyes of pedestrians and play a good publicity effect
 - Through them, the city becomes more lively and adds a bright color to the life of its citizens.
 - Intelligent temperature control and heat dissipation, synchronous no delay switching screen
 - Environmental durability: IP65



亮度	5000-5500cd
Smart features	
平均功耗	90W
Smart features	
峰值功耗	260W
Security features	
刷新频率	>3840Hz
IR	



T-103SM



模组式太阳能圆形柱灯
Modular
Solar Column Lighting



- 铝压铸灯体外壳，高透明PC透明管
- 模组式高效单晶硅太阳能组件，可以套接组装
- 采用模组式光学透镜，多种光学可选
- Q355材质钢管，热镀锌后喷涂处理
- 无生物蓝光危害风险，符合EN62471：2008标准
- 采用通常用于电动客车的LiFePO₄电池
- 防紫外线聚氨酯塑粉喷涂表面，耐腐蚀可以达1000小时以上
- 一体化包装，运输方便
- 所有外部螺钉均为304不锈钢材质

- Die-casting aluminium body, PC transparent diffuser tube.
- Efficient monocrystalline silicon solar panels.
- Comfort using modular optical lens, multiple optical options.
- Q355 steel pole, after galvanized process, then by anti-ultraviolet pure polyester powder painting.
- No photo-biological risk,(no risk linked to infrared,blue light and UV radiation) in accordance with EN 62471:2008.
- With LiFePO₄ battery which usually apply for electric bus.
- Surface anti-ultraviolet pure polyester powder painting, Corrosion resistance can be more than 1000 hours.
- Integrated package, convenient transportation.
- All external screws are made of 304 stainless steel.

远程控制系统和智能系统可选
Remote control system & Smart intelligent system available upon request



节能控制系统
 Energy saving with remote control system



物联网智能系统
 Network for smart intelligent system



遥控器
 Remote control

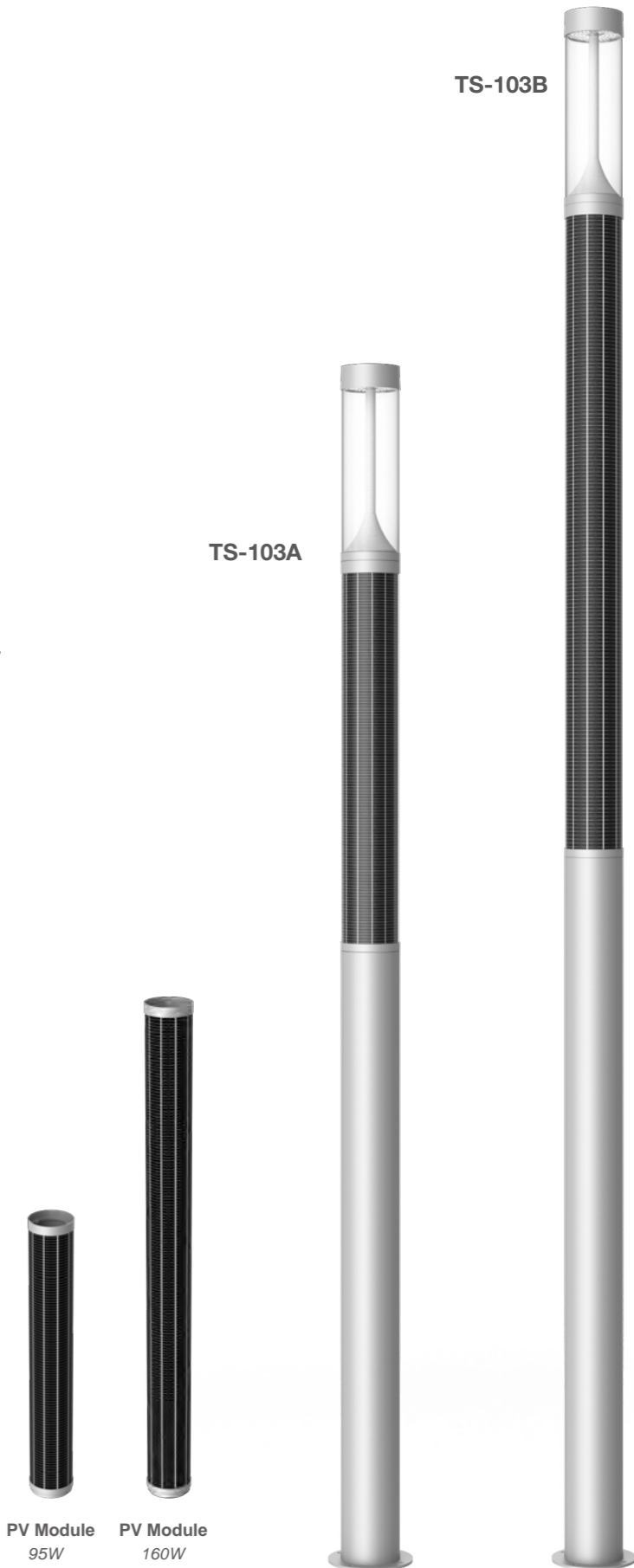

应用透镜 Optics application

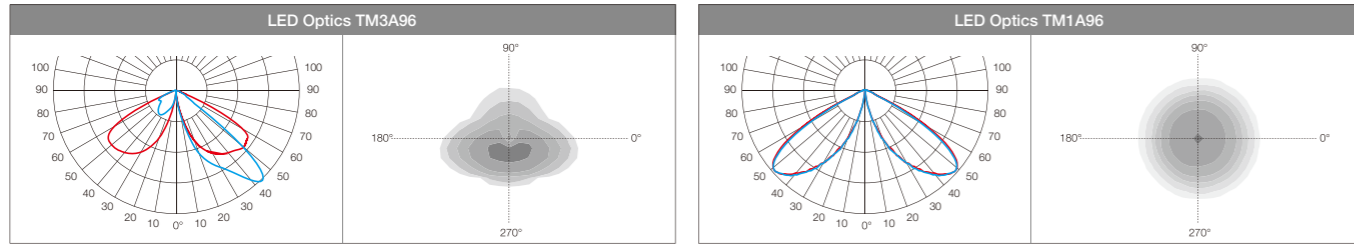

TS-103 Series

Modular Solar Column Lighting

Technical Data

SOLAR-GENERAL

Autonomy Information : 2 days
 Working mode : 2hrs - 100%, 2hrs - 50%, 7hrs - 30%

Model 灯具型号	Power 功率	Solar PV 太阳能板	LiFePO ₄ Battery 电池	Luminous 光通量	LED Chips LED灯珠
TS-103ALED25	25W	18V/95W	384WH/12.8V 30AH	3750 lm	3030*96pcs
TS-103BLED50	50W	18V/160W	384WH/12.8V 42AH	7500 lm	3030*96pcs

SOLAR-ADVANCE

Autonomy Information : 3 days
 Working mode : 2hrs - 100%, 2hrs - 50%, 7hrs - 30%

Model 灯具型号	Power 功率	Solar PV 太阳能板	LiFePO ₄ Battery 电池	Luminous 光通量	LED Chips LED灯珠
TS-103ALED20	20W	18V/95W	384WH/12.8V 30AH	3000 lm	3030*96pcs
TS-103BLED40	40W	18V/160W	384WH/12.8V 42AH	6000 lm	3030*96pcs

产品尺寸 Product dimensions

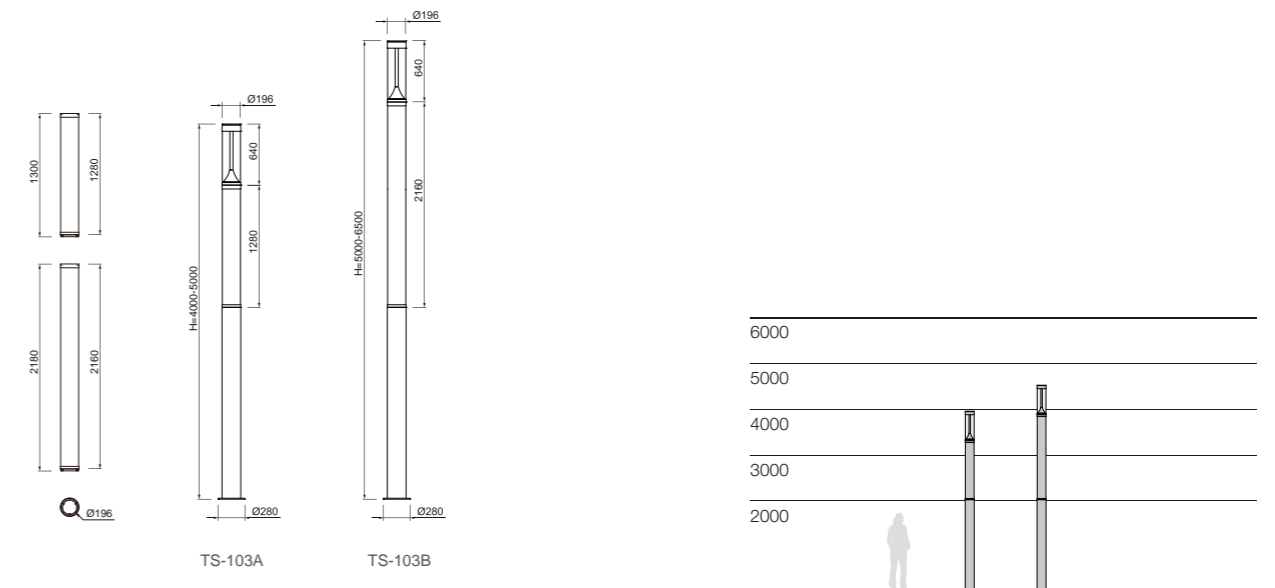

延伸产品

MORE IN FAMILY

T-103 Series

