

TG-163N Series
A High Power LED Flood Lighting



TG-163NS
400-600W



TG-163NL
800-1200W



TG-163NXL
1200-1800W





TG-163N Series

一款超越同类产品的具备电视转播一致性指数 (TLCI) 的LED体育场照明灯具, 并提供多种光学系统, 能满足各类体育场地的照明需求。

A LED stadium lighting fixture with TLCI (Television Lighting Consistency Index) that surpasses similar products and provides a variety of optical systems to meet the lighting needs of various stadiums.

3 SIZES

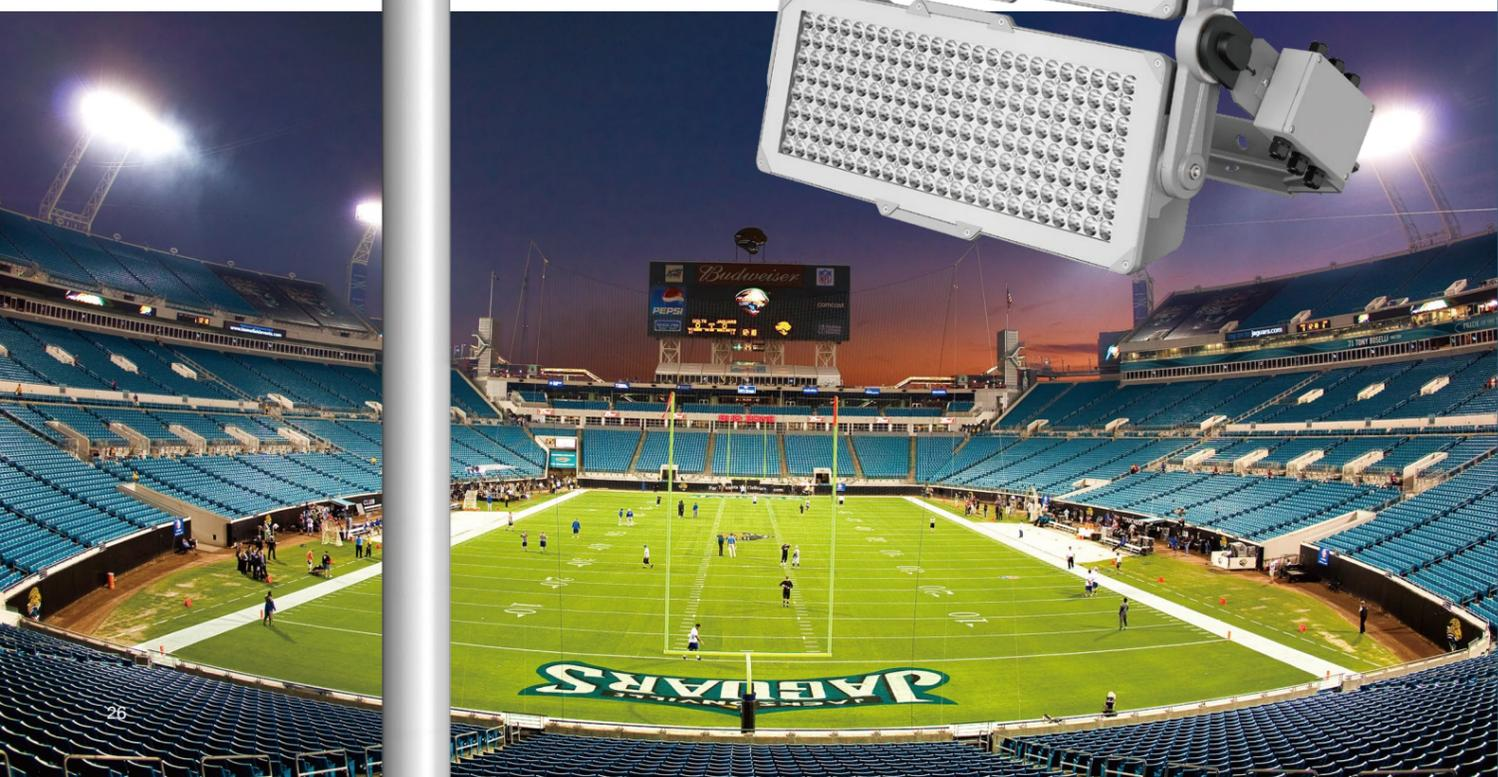

简述 Description



- 灯具外壳采用6063铝型材而成, 灯具电器箱和光源模组采用分离式独立结构
- 高效反光杯光学设计, 具有高视觉舒适性和均匀配光透镜, 供多种不同配光选择
- 支架采用独特设计, 可调节多种角度, 满足更多照明需求
- 防紫外线聚氨酯塑料喷涂表面, 盐雾测试可以达1000小时以上
- 无生物蓝光危害风险, 符合EN62471: 2008标准
- 所有外部螺钉均为304不锈钢材质

- The luminaire housing is made of 6063 aluminum profiles, the electrical box and light module adopt separate independent structure.
- Optics with reflector design with high visual comfortable and uniform lighting distribution, multiple light distribution options.
- The unique design of the bracket can adjust a variety of angles to meet more lighting needs.
- Surface anti-ultraviolet pure polyester powder painting, Corrosion resistance can be more than 1000 hours.
- No photo-biological risk, (no risk linked to infrared, blue light and UV radiation) in accordance with EN 62471:2008.
- All external screws are made of 304 stainless steel.

抗振等级: 通过5G / 15Hz / 3轴各10万次振动测试
 风压测试: >65m/s
 功率: 400W-1800W
 光效: 120-150 Lm/W
 色温: 4000K / 5000K / 5700K
 显色指数: >80Ra / 90Ra
 功能选项: 0-10V / DALI / DMX / RGBW

Anti vibration grade: Passed 100K times vibration tests of 5G / 15Hz / 3 axis.
 Wind pressure test: >65m/s
 Power: 400W-1800W
 Nominal efficacy: 120-150 Lm/W
 CCT: 4000K / 5000K / 5700K
 CRI: >80Ra / 90Ra
 Options: 0-10V / DALI / DMX / RGBW

- 应用场合: 体育馆、港口码头、机场及大型建筑立面泛光照明
- Applications: Sport stadium, port, and larger building illumination.

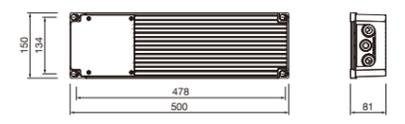

智能一体式驱动 Intelligent driver

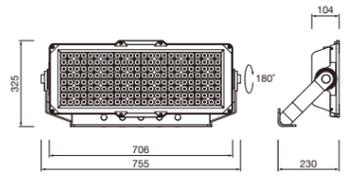

TG-163NS

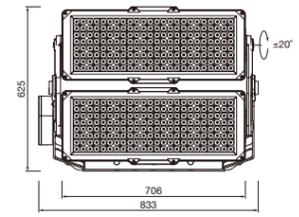

TG-163NL

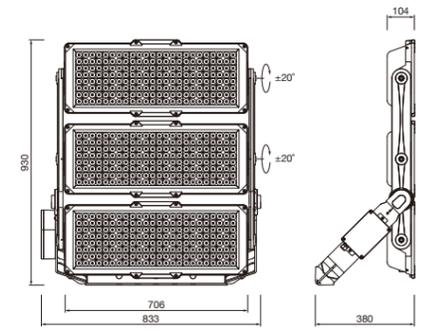

TG-163NXL



特殊设计散热系统，能可靠保证灯具的光维持率和寿命，并每个模组角度可调，角度调节范围±20度

The specially designed heat dissipation can reliably ensure the light maintenance and lifetime. The angle of each module is adjustable, and the angle adjustment range is ±20 degree.

智能一体式驱动
Intelligent integrated driver



DMX DALI

无论是大型体育场、娱乐场还是区域性照明，紧凑型专业驱动在所有类型的安装中都能提供便捷和卓越的性能

Whether large stadiums, casinos or area illumination compact special lighting driver can provide high performance and more convenient in all of installations.



灯具安装时通过瞄准器精准控制光的投射位置，角度调整完毕后装上安全绳，能防止灯具的意外跌落

When installing lamps and lanterns, the projection position of the light is precisely controlled by the aiming sight, and the safety rope is installed after the angle adjustment, which can prevent the lamps and lanterns from falling unexpectedly.



旋转固定螺钉，外加塑料防护盖，能方便调节灯具的投射角度

Complete with protractor scale for precise aiming of the floodlight.

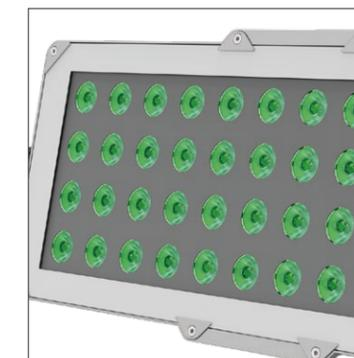

不对称反光杯 Asymmetric reflector optics

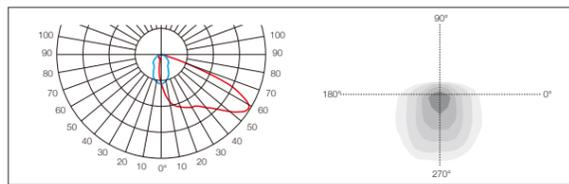

AH1
适用于运动场、广场、十字路口、停车场等区域照明
Asymmetrical Optic 40° * 70°
For sports ground, square, intersection, parking and other areas.

LED Chips: 4 in 1

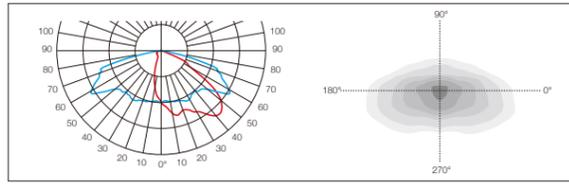

AH3
适用于运动场、广场、十字路口、停车场等区域照明
Asymmetrical Optic TYPE II
For sports ground, square, intersection, parking and other areas.

LED Chips: 4 in 1

单颗对称透镜 Beam lens optics

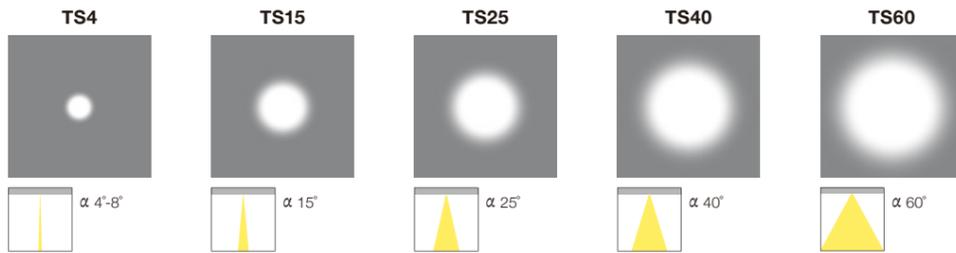

组合对称透镜 Symmetric lens optics

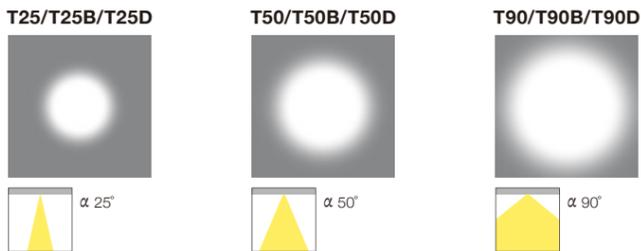

对称反光杯 Symmetric reflector optics

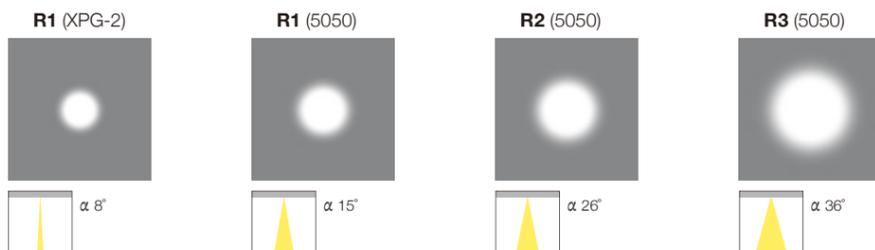
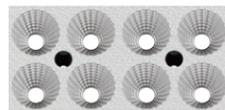

技术参数 Technology data



TG-163NS

Code	Power	LED Qty	Optics	Packing Size	Weight	Pcs/20"	Pcs/40"
LED chips - 3535/5050							
TG-163NSLED400-192	400W	192	R1/R2/R3/T50/T90	780*415*230	12.5	315	675
TG-163NSLED480-192	480W	192	R1/R2/R3/T50/T90	780*415*230	12.5	315	675
TG-163NSLED600-192	600W	192	R1/R2/R3/T50/T90	780*415*230	12.5	315	675
LED chips - 5050RGBW							
TG-163NSLED480-48RGBW	480W	48	TS25/TS40/TS60	780*415*230	12.5	315	675



TG-163NL

Code	Power	LED Qty	Optics	Packing Size	Weight	Pcs/20"	Pcs/40"
LED chips - 3535/5050							
TG-163NLLED800-384	800W	384	R1/R2/R3/T50/T90	Luminaire: 870*820*165 Body: 26	26	182	364
TG-163NLLED1000-384	1000W	384	R1/R2/R3/T50/T90	870*820*165	26	182	364
TG-163NLLED1200-384	1200W	384	R1/R2/R3/T50/T90	870*820*165	26	182	364
LED chips - 5050RGBW							
TG-163NLLED1000-96RGBW	1000W	96	TS25/TS40/TS60	870*820*165	26	182	364
Remark: Intelligent integrated driver: 5.5kg Luminaire weight: 26kg							



TG-163NXL

Code	Power	LED Qty	Optics	Packing Size	Weight	Pcs/20"	Pcs/40"
LED chips - 3535/5050							
TG-163NXLLED1500-576	1500W	576	R1/R2/R3/T50/T90	Luminaire: 1150*870*165 Body: 38.4	38.4	134	278
TG-163NXLLED1800-576	1800W	576	R1/R2/R3/T50/T90	1150*870*165	38.4	134	278
LED chips - 5050RGBW							
TG-163NXLLED1500-144RGBW	1500W	144	TS25/TS40/TS60	1150*870*165	38.4	134	278
Remark: Intelligent integrated driver: 6kg Luminaire weight: 38.4kg							



TG-163N PROJECTS

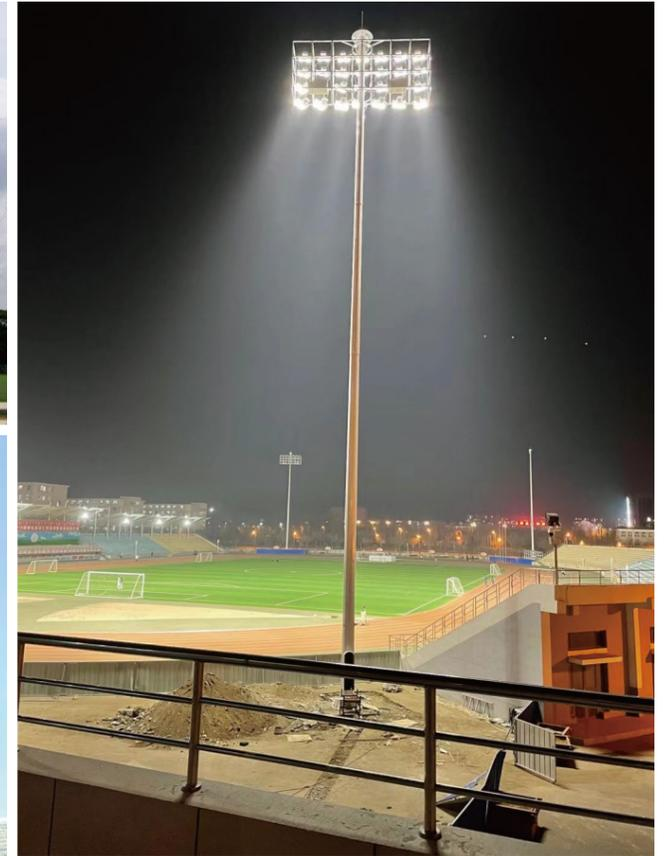
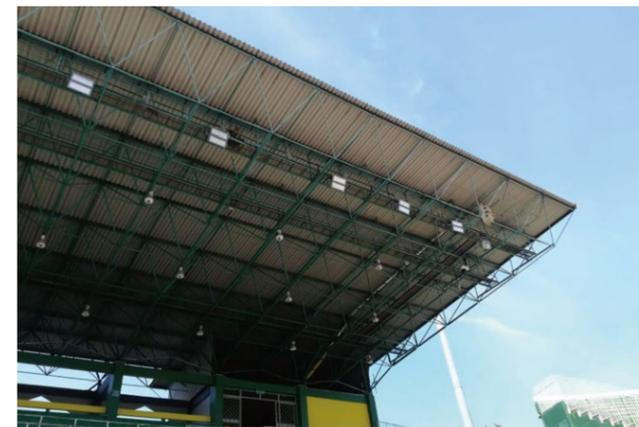

延伸产品 More in family



F-163NS

For High Bay Lighting: 300~480W.