

宁波金羽桥照明科技有限公司
NINGBO KING-BRIDGE LIGHTING
TECHNOLOGY CO.,LTD.

地址：浙江省余姚市阳明街道新桥工业区
Add: Xinqiao Industry Zone, Yangming Street, Yuyao City,
Zhejiang Province, China
Tel: +86-574-6256 6890
Fax: +86-574-6256 6827
info@kled.com

国内营销中心:

金羽桥照明科技（上海）有限公司
地址：上海市长宁区中山西路179号4K室
电话：189 1897 7928

Bollard Lighting





Bollard Lighting

Visual comfort is extremely, very sturdy to withstand acts of vandalism.

P6	C-231	P26	C-233
P8	C-190	P30	C-234
P10	C-12 / C-12D	P32	C-232S
P12	C-13	P34	C-242
P12	C-13A	P38	C-243
P14	C-13B		
P16	C-14		
P16	C-14F		
P18	C-14FA		
P18	C-14FG		
P20	C-140		
P22	C-142		
P24	C-162		

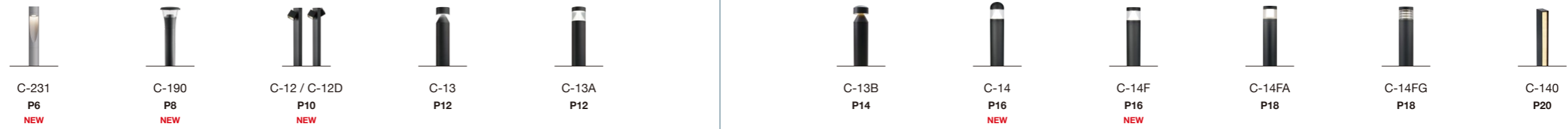

Power	15W	12W	12-18W	12W	12W	25W	25W	25W	12W	25W	10-25W
Light flux LM	1275	1080	1300→1900	1250	1300	2650	2650	2650	1300	2300	1050→2130
Colour temperature K	3000 / 4000	3000 / 4000	3000 / 4000	3000 / 4000	3000 / 4000	3000 / 4000	3000 / 4000	3000 / 4000	3000 / 4000	3000 / 4000	3000 / 4000
Double colour temperature options	-	-	-	●	●	●	●	●	●	●	-
Sensor options	-	●	-	●	●	●	●	●	●	●	-
Emergency options	-	-	-	-	-	●	●	●	●	●	-
DALI	-	●	-	●	●	●	●	●	●	●	-
Floor-mounted	●	●	●	●	●	●	●	●	●	●	●
Wall-mounted	-	●	●	●	●	●	-	●	●	●	●
Number of size	2	2	2	1	1	2	1	1	1	1	2

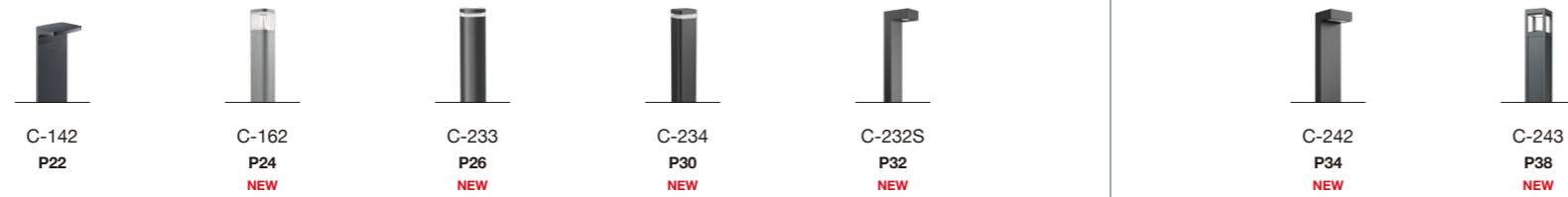

Power	3-12W	15-30W	9-25W	25W	12W	12-25W	25W
Light flux LM	180→1150	1600→3200	810→2500	2500	1300	1500→3750	1500
Colour temperature K	3000 / 4000	3000 / 4000	3000 / 4000	3000 / 4000	3000 / 4000	3000 / 4000	3000 / 4000
Double colour temperature options	-	●	●	●	●	●	●
Sensor options	●	●	●	●	-	-	-
Emergency options	-	●	●	●	-	-	-
DALI	-	●	●	●	●	●	●
Floor-mounted	●	●	●	●	●	●	●
Wall-mounted	●	-	-	-	-	●	-
Number of size	2	2	2	1	1	3	1



C-231 Series



简述 Description



- 铝压铸灯体外壳，铝合金拉伸灯杆，高度根据客户需要截取
 - 模组式光源模块配超白钢化玻璃，具有很好的光舒适性
 - 防紫外线聚氨酯塑粉喷涂表面，耐腐蚀可以达到1000小时以上
 - 灯具表面最高温度不超过50度，安全可靠
 - 所有外部螺钉均为304不锈钢材质，底座埋件额外可选配
- Aluminum die casting cover, extruded aluminum body, it can be cut different height.
 - LED module design and with supper tempered galss, It has more comfortable light effect.
 - Surface anti-ultraviolet pure polyester powder painting, Corrosion resistance can be more than 1000 hours.
 - The maximum surface temperature of all accessible part under 50 degrees for safety and reliable.
 - All external screws are made of 304 stainless steel, Additional optional base embedded parts.

配光曲线 Photometric Data

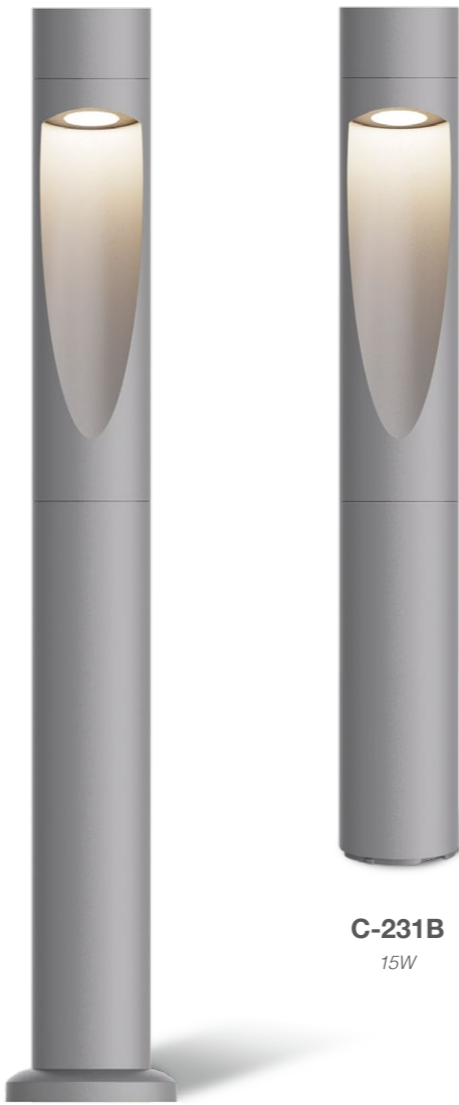
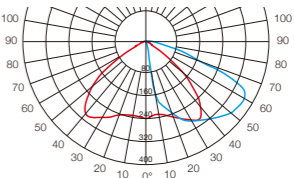

C-231A
15W

C-231B
15W

技术参数 Technology data

Code	Power	LED Qty	Input Voltage	Packing Size	Weight
LED chips - 5050					
C-231ALED15-5-H80	15W	5	100V-240V	830*385*380/4pcs	14.8
C-231ALED15-5-H100	15W	5	100V-240V	1030*385*380/4pcs	17.8
LED chips - 5050					
C-231BLED15-5-H80	15W	5	100V-240V	830*285*290/4pcs	14.8
C-231BLED15-5-H100	15W	5	100V-240V	1030*285*290/4pcs	17.8

延伸产品 More in family



T-231A / T-231B / T-231C
Residential Lighting: 40W / 80W / 120W.

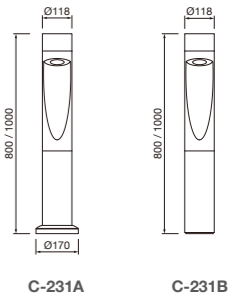

可选配件 Accessories options

	Code
装饰盖 Decorative Cover	220001875
Q-02H防水连接器 Terminal Box	320000698
基础预埋件 Anchor Bolts	250000377
膨胀螺钉 Expansion Bolts	613040003



C-190 Series



简述 Description

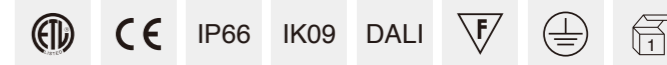

- 铝压铸盖帽, 铝合金拉伸灯体, 可根据需要截取不同高度
 - 高透明PC扩散罩, 能有效防止发黄老化
 - 灯具采用间接投射发光模式, 具有很好的视觉舒适性
 - 高性能LED芯片, 驱动有0-10V / DALI / 编程电源选择
 - 防紫外线聚氨酯塑粉喷涂表面, 耐腐蚀可以达1000小时以上
 - 灯具表面最高温度不超过50度, 安全可靠
- Aluminum die casting cover, extruded aluminum body, it can be cut different height.
 - High transparent PC diffuser, it can effectively prevent yellowing and aging.
 - Indirect light luminaire for use with led, which has high visual comfortable.
 - High quality LED chips, Driver with 0-10V/DALI/programmed options.
 - Surface anti-ultraviolet pure polyester powder painting.
 - The maximum surface temperature of all accessible part under 50 degrees.

其他功能选项: 移动感应功能 / 双色温切换功能

Other Options: Move sensor options / Colour temperature options

配光曲线 Photometric Data

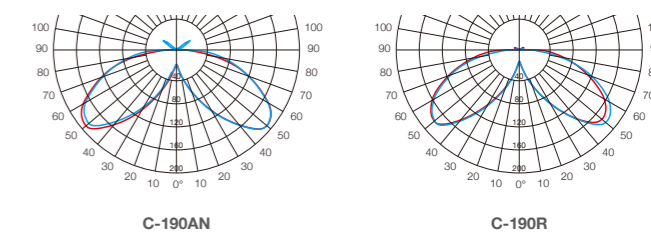

C-190N
12W

C-190R
12W

技术参数 Technology data

Code	Power	LED Qty	Input Voltage	Packing Size	Weight
LED chips - 5050					
C-190NLED12-6H60	12W	6	100V-240V	630*235*240	3.3
C-190NLED12-6H80	12W	6	100V-240V	830*235*240	3.7
C-190NLED12-6H100	12W	6	100V-240V	1030*235*240	4.1
LED chips - 5050					
C-190RLED12-5H60	12W	5	100V-240V	630*235*240	3.3
C-190RLED12-5H80	12W	5	100V-240V	830*235*240	3.7
C-190RLED12-5H100	12W	5	100V-240V	1030*235*240	4.1

可选配件 Accessories options

	Code
装饰盖 Decorative Cover	220001875
Q-02H防水连接器 Terminal Box	320000698
基础预埋件 Anchor Bolts	250000377
膨胀螺钉 Expansion Bolts	613040003
基础锚 Anchor	250000272

延伸产品 More in family



B-190R

Wall Lighting: 12W.

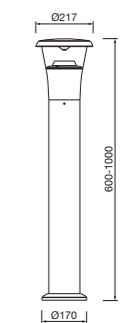



简述 Description

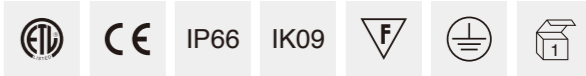

- 铝压铸灯体外壳，铝合金拉伸灯杆，高度根据客户需要截取
- 模组式光源模块配超白钢化玻璃，灯具模组角度可调
- 防紫外线聚氨酯塑粉喷涂表面，耐腐蚀可以达1000小时以上
- 灯具表面最高温度不超过50度，安全可靠
- 所有外部螺钉均为304不锈钢材质，底座埋件额外可选配

- Aluminum die casting cover, extruded aluminum body, it can be cut different height.
- LED module design and with supper tempered galss, and the module angle can adjustable.
- Surface anti-ultraviolet pure polyester powder painting, Corrosion resistance can be more than 1000 hours.
- The maximum surface temperature of all accessible part under 50 degrees for safety and reliable.
- All external screws are made of 304 stainless steel, Additional optional base embedded parts.

配光曲线 Photometric Data

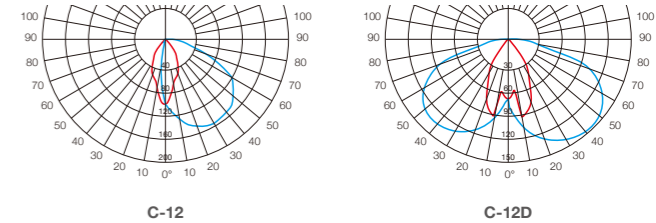

C-12
12W

C-12D
18W

技术参数 Technology data

Code	Power	LED Qty	Input Voltage	Packing Size	Weight
LED chips - 3030					
C-12LED12-10H80	12W	10	100V-240V	835*215*170	2.4
C-12LED12-10H100	12W	10	100V-240V	1035*215*170	2.6
LED chips - 3030					
C-12DLED18-20H80	18W	20	100V-240V	835*310*170	3.0
C-12DLED18-20H100	18W	20	100V-240V	1035*310*170	3.2

可选配件 Accessories options

	Code
防水接线盒 Terminal Box	230000232
基础预埋件 Anchor Bolts	250000377
膨胀螺钉 Expansion Bolts	613040003

延伸产品 More in family



B-12

Wall Lighting: 12W.

B-12D

Wall Lighting: 18W.

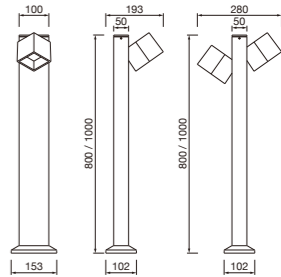

C-12

C-12D



简述 Description



- 铝压铸盖帽，铝合金拉伸灯体，可根据需要截取不同高度
 - 高透明PC扩散罩，能有效防止发黄老化
 - 灯具采用间接投射发光模式，具有很好的视觉舒适性
 - 高性能LED芯片，驱动有0-10V / DALI / 编程电源选择
 - 防紫外线聚氨酯塑粉喷涂表面，耐腐蚀可以达到1000小时以上
 - 灯具表面最高温度不超过50度，安全可靠
- Aluminum die casting cover, extruded aluminum body, it can be cut different height.
 - High transparent PC diffuser, it can effectively prevent yellowing and aging.
 - Indirect light luminaire for use with led, which has high visual comfortable.
 - High quality LED chips, Driver with 0-10V/DALI/programmed options.
 - Surface anti-ultraviolet pure polyester powder painting.
 - The maximum surface temperature of all accessible part under 50 degrees.

其他功能选项：移动感应功能 / 双色温切换功能

Other Options: Move sensor options / Colour temperature options

配光曲线 Photometric Data

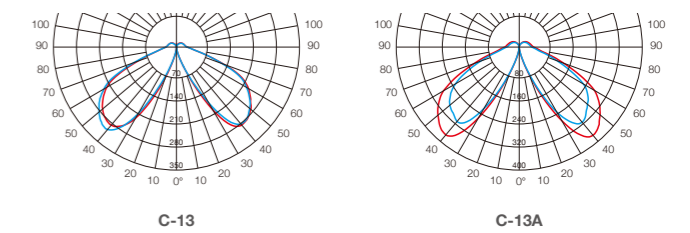

C-13
12W

C-13A
12W

技术参数 Technology data

Code	Power	LED Qty	Input Voltage	Packing Size	Weight
LED chips - 2835					
C-13LED12-42H50	12W	42	100V-240V	530*285*290/4pcs	9.9
C-13LED12-42H80	12W	42	100V-240V	830*285*290/4pcs	13.8
LED chips - 2835					
C-13ALE12-56H50	12W	56	100V-240V	530*285*290/4pcs	9.9
C-13ALE12-56H80	12W	56	100V-240V	830*285*290/4pcs	13.8

可选配件 Accessories options

	Code
装饰盖 Decorative Cover	220001875
防水接线盒 Terminal Box	230000232
基础预埋件 Anchor Bolts	250000377
膨胀螺钉 Expansion Bolts	613040003

延伸产品 More in family



B-13A

Wall Lighting: 12W.

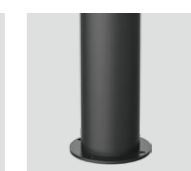

C-13-A / C-13A-A

With Flange Version.

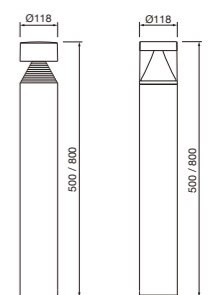

C-13

C-13A



简述 Description

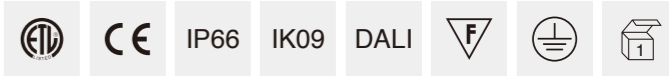

- 铝压铸盖帽，铝合金拉伸灯体，可根据需要截取不同高度
- 高透明PC扩散罩，能有效防止发黄老化
- 灯具采用间接投射发光模式，具有很好的视觉舒适性
- 高性能LED芯片，驱动有0-10V / DALI / 编程电源选择
- 防紫外线聚氨酯粉末喷涂表面，耐腐蚀可以达1000小时以上
- 灯具表面最高温度不超过50度，安全可靠

- Aluminum die casting cover, extruded aluminum body, it can be cut different height.
- High transparent PC diffuser, it can effectively prevent yellowing and aging.
- Indirect light luminaire for use with led, which has high visual comfortable.
- High quality LED chips, Driver with 0-10V/DALI/programmed options.
- Surface anti-ultraviolet pure polyester powder painting.
- The maximum surface temperature of all accessible part under 50 degrees.

其他功能选项：移动感应功能 / 应急功能 / 双色温切换功能

Other Options: Move sensor options / Emergency options / Colour temperature options

配光曲线 Photometric Data

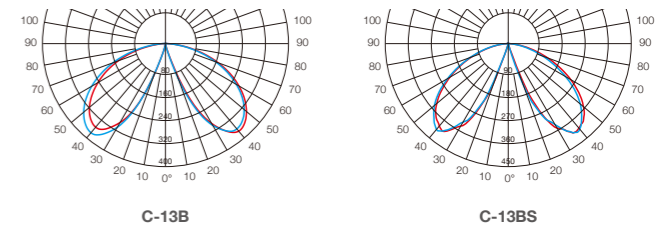

C-13B
25W

C-13BS
25W

技术参数 Technology data

Code	Power	LED Qty	Input Voltage	Packing Size	Weight
LED chips - 2835					
C-13BLE25-56H80	25W	56	100V-240V	830*235*240	5.5
C-13BLE25-56H100	25W	56	100V-240V	1030*285*290	6.3
LED chips - 2835					
C-13BSLED25-56H80	25W	56	100V-240V	830*235*240	5.3
C-13BSLED25-56H100	25W	56	100V-240V	1030*285*290	6.0

可选配件 Accessories options

	Code
Q-02H防水连接器 Terminal Box	320000698
基础预埋件 Anchor Bolts	250000378
基础锚 Anchor	250000379

延伸产品 More in family



B-13B
Wall Lighting: 25W.



C-13BS-B
Without Flange Version.

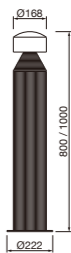

C-13B



C-13BS



简述 Description



- 铝压铸盖帽，铝合金拉伸灯体，可根据需要截取不同高度
- 高透明PC扩散罩，能有效防止发黄老化
- 灯具采用间接投射发光模式，具有很好的视觉舒适性
- 高性能LED芯片，驱动有0-10V / DALI / 编程电源选择
- 防紫外线聚氨酯塑粉喷涂表面，耐腐蚀可以达1000小时以上
- 灯具表面最高温度不超过50度，安全可靠

- Aluminum die casting cover, extruded aluminum body, it can be cut different height.
- High transparent PC diffuser, it can effectively prevent yellowing and aging.
- Indirect light luminaire for use with led, which has high visual comfortable.
- High quality LED chips, Driver with 0-10V/DALI/programmed options.
- Surface anti-ultraviolet pure polyester powder painting.
- The maximum surface temperature of all accessible part under 50 degrees.

其他功能选项：移动感应功能 / 应急功能 / 双色温切换功能

Other Options: Move sensor options / Emergency options / Colour temperature options

配光曲线 Photometric Data

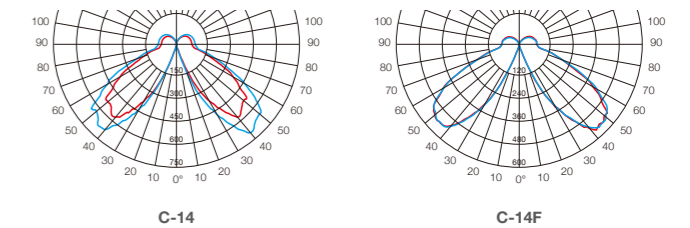

C-14
25W

C-14F
25W

技术参数 Technology data

Code	Power	LED Qty	Input Voltage	Packing Size	Weight
LED chips - 2835					
C-14LED25-132H80	25W	132	100V-240V	185*185*820	4.6
C-14LED25-132H100	25W	132	100V-240V	185*185*1020	5.3
LED chips - 2835					
C-14FLED25-132H80	25W	132	100V-240V	185*185*820	4.7
C-14FLED25-132H100	25W	132	100V-240V	185*185*1020	5.4

可选配件 Accessories options

	Code
Q-02H防水连接器 Terminal Box	320000698
基础预埋件 Anchor Bolts	250000378
基础锚 Anchor	250000379

延伸产品 More in family

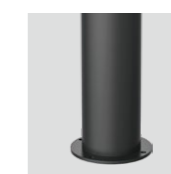

C-14-A / C-14F-A

With Flange Version.

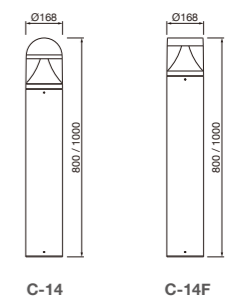



简述 Description

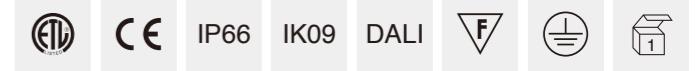

- 铝压铸盖帽，铝合金拉伸灯体，可根据需要截取不同高度
- 高透明PC扩散罩，能有效防止发黄老化
- 灯具采用间接投射发光模式，具有很好的视觉舒适性
- 高性能LED芯片，驱动有0-10V / DALI / 编程电源选择
- 防紫外线聚氨酯塑粉喷涂表面，耐腐蚀可以达1000小时以上
- 灯具表面最高温度不超过50度，安全可靠

- Aluminum die casting cover, extruded aluminum body, it can be cut different height.
- High transparent PC diffuser, it can effectively prevent yellowing and aging.
- Indirect light luminaire for use with led, which has high visual comfortable.
- High quality LED chips, Driver with 0-10V/DALI/programmed options.
- Surface anti-ultraviolet pure polyester powder painting.
- The maximum surface temperature of all accessible part under 50 degrees.

其他功能选项: 移动感应功能 / 应急功能 / 双色温切换功能

Other Options: Move sensor options / Emergency options / Colour temperature options

配光曲线 Photometric Data

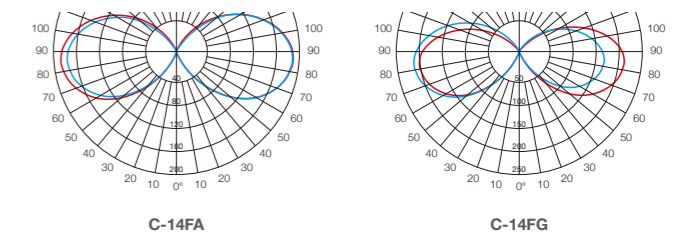

技术参数 Technology data

Code	Power	LED Qty	Input Voltage	Packing Size	Weight
LED chips - 2835					
C-14FALED12-144H80	12W	144	100V-240V	185*185*820	5.1
C-14FALED12-144H100	12W	144	100V-240V	185*185*1020	5.8
LED chips - 2835					
C-14FGLED25-144H80	25W	144	100V-240V	185*185*820	5.1
C-14FGLED25-144H100	25W	144	100V-240V	185*185*1020	5.8

可选配件 Accessories options

	Code
Q-02H防水连接器 Terminal Box	320000698
基础预埋件 Anchor Bolts	250000378
基础锚 Anchor	250000379

延伸产品 More in family

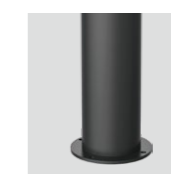

C-14FA-A / C-14FG-A

With Flange Version.

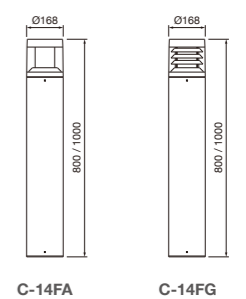



简述 Description

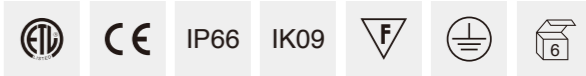

- 铝压铸盖帽，铝合金拉伸灯体，可根据需要截取不同高度
- 高透明PC扩散罩，能有效防止发黄老化
- 防紫外线聚氨酯塑粉喷涂表面，耐腐蚀可以达1000小时以上
- 灯具表面最高温度不超过50度，安全可靠
- 所有外部螺钉均为304不锈钢材质，底座埋件额外可选配

- Aluminum die casting cover, extruded aluminum body, it can be cut different height.
- High transparent PC diffuser, it can effectively prevent yellowing and aging.
- Surface anti-ultraviolet pure polyester powder painting, Corrosion resistance can be more than 1000 hours.
- The maximum surface temperature of all accessible part under 50 degrees for safety and reliable.
- All external screws are made of 304 stainless steel, Additional optional base embedded parts.

配光曲线 Photometric Data

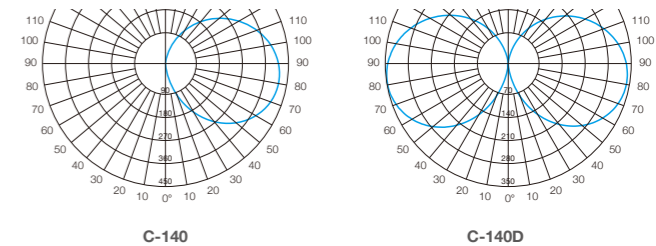

C-140
10W/15W

C-140D
15W/25W

技术参数 Technology data

Code	Power	LED Qty	Input Voltage	Packing Size	Weight
LED chips - 2835					
C-140LED10-84H45	10W	84	100V-240V	520*285*300/6pcs	12.2
C-140LED15-120H60	15W	120	100V-240V	670*285*300/6pcs	14.2
LED chips - 2835					
C-140DLED15-168H45	15W	168	100V-240V	520*285*300/6pcs	12.6
C-140DLED25-240H60	25W	240	100V-240V	670*285*300/6pcs	14.8

可选配件 Accessories options

	Code
防水接线盒 Terminal Box	230000232

延伸产品 More in family



B-140
Wall Lighting: 6W.

B-140D
Wall Lighting: 12W.

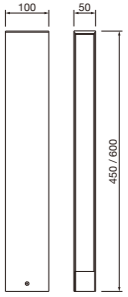



简述 Description

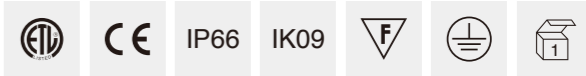

- 铝压铸盖帽，铝合金拉伸灯体，可根据需要截取不同高度
- PC棱纹透明罩，具有高视觉舒适性和均匀配光透镜
- 灯具具有常规供电和太阳能供电2个版本供选择
- 防紫外线聚氨酯塑粉喷涂表面，耐腐蚀可达1000小时以上
- 灯具表面最高温度不超过50度，安全可靠

- Aluminum die casting base and heatsink, extruded aluminum alloy body.
- PC prism transparent diffuser with high visual comfortable and uniform lighting distribution.
- There are two version design: AC input normally version and solar version.
- Surface anti-ultraviolet pure polyester powder painting.
- The maximum surface temperature of all accessible part under 50 degrees.

其他功能选项：移动感应功能 / 双色温切换功能

Other Options: Move sensor options / Colour temperature options



配光曲线 Photometric Data

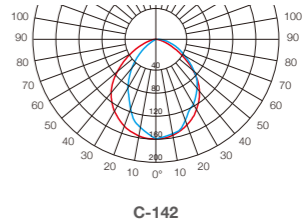

技术参数 Technology data

Code	Power	LED Qty	Input Voltage	Packing Size	Weight
LED chips - 2835					
C-142LED12-60H65	12W	60	100V-240V	675*230*190	3.2
LED chips - 2835, With Solar					
C-142SLED3-25H65	2.5W/0.1W	25	SOLAR+SENSOR	675*230*190	3.2

可选配件 Accessories options

	Code
防水接线盒 Terminal Box	230000232
膨胀螺钉 Expansion Bolts	613040003

延伸产品 More in family



B-142

Wall Lighting: 12W.

B-142S

Wall Lighting: 2.5W / 0.1W.

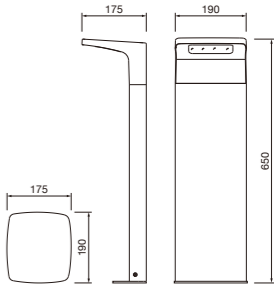



简述 Description

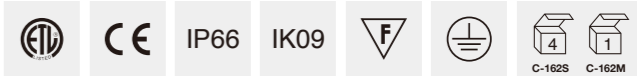

- 铝压铸盖帽，铝合金拉伸灯体，可根据需要截取不同高度
- 高透明PC扩散罩，能有效防止发黄老化
- 灯具采用间接投射发光模式，具有很好的视觉舒适性
- 高性能LED芯片，驱动有0-10V / DALI / 编程电源选择
- 防紫外线聚氨酯塑粉喷涂表面，耐腐蚀可达1000小时以上
- 灯具表面最高温度不超过50度，安全可靠

- Aluminum die casting cover, extruded aluminum body, it can be cut different height.
- High transparent PC diffuser, it can effectively prevent yellowing and aging.
- Indirect light luminaire for use with led, which has high visual comfortable.
- High quality LED chips, Driver with 0-10V/DALI/programmed options.
- Surface anti-ultraviolet pure polyester powder painting.
- The maximum surface temperature of all accessible part under 50 degrees.

其他功能选项：移动感应功能 / 应急功能 / 双色温切换功能

Other Options: Move sensor options / Emergency options / Colour temperature options

配光曲线 Photometric Data

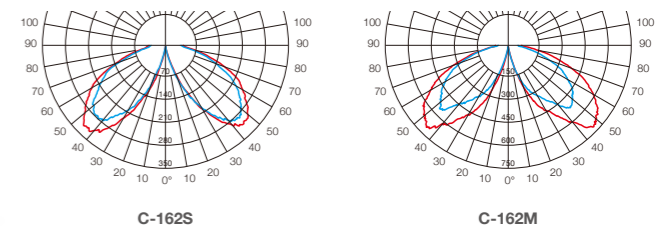

技术参数 Technology data

Code	Power	LED Qty	Input Voltage	Packing Size	Weight
LED chips - 3030					
C-162SLED15-132H60	15W	132	100V-240V	630*285*290/4pcs	10.8
C-162SLED15-132H80	15W	132	100V-240V	830*285*290/4pcs	12.8
LED chips - 3030					
C-162MLED30-168H80	30W	168	100V-240V	830*235*240	7.1
C-162MLED30-168H100	30W	168	100V-240V	1030*235*240	8.5

可选配件 Accessories options

	Code
Q-02H防水连接器 Terminal Box	320000698
基础螺杆 Anchor Bolts	250000380
基础锚 Anchor	250000381

延伸产品 More in family



C-162S-A
With Flange Version.

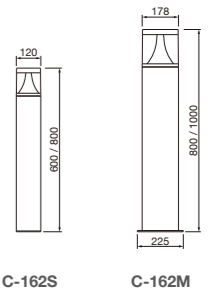



C-233 Series



简述 Description

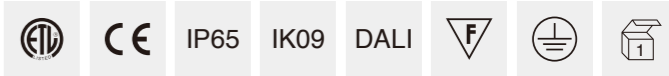

- 具有180° 和360° 两种配光
 - 铝压铸盖帽，铝合金拉伸灯体，可根据需要截取不同高度
 - 高透明PC扩散罩，能有效防止发黄老化
 - 灯具采用间接投射发光模式，具有很好的视觉舒适性
 - 无生物蓝光危害风险，符合EN62471: 2008标准
 - 防紫外线聚氨酯塑粉喷涂表面，耐腐蚀可以达1000小时以上
 - 灯具表面最高温度不超过50度，安全可靠
- With 180° or 360° light distribution.
 - Aluminum die casting cover, extruded aluminum body, it can be cut different height.
 - High transparent PC diffuser, it can effectively prevent yellowing and aging.
 - Indirect light luminaire for use with led, which has high visual comfortable.
 - No photo-biological risk, (no risk linked to infrared, blue light and UV radiation) in accordance with EN 62471:2008.
 - Surface anti-ultraviolet pure polyester powder painting.
 - The maximum surface temperature of all accessible part under 50 degrees.

其他功能选项：双色温切换功能
Other Options: CCT option



C-233SA

C-233SB



Light emission 180°

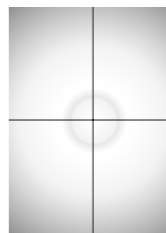

Light emission 360°



C-233A

C-233B

延伸产品 More in family



CS-233A



CS-233B

Solar Bollard Lighting: 3W.

C-233 Series

技术参数 Technology data



C-233SA

Code	Power	LED Qty	Input Voltage	Packing Size	Weight
LED chips - 2835					
C-233SALED12-42-H30	12W	42	100V-240V	630*280*285/8pcs	6.3
C-233SALED12-42-H50	12W	42	100V-240V	530*280*285/4pcs	5.2
C-233SALED12-42-H80	12W	42	100V-240V	830*280*285/4pcs	9.9
C-233SALED12-42-H100	12W	42	100V-240V	1030*280*285/4pcs	13.8



C-233SB

Code	Power	LED Qty	Input Voltage	Packing Size	Weight
LED chips - 2835					
C-233SBLED9-28-H30	9W	28	100V-240V	630*280*285/8pcs	6.3
C-233SBLED9-28-H50	9W	28	100V-240V	530*280*285/4pcs	5.2
C-233SBLED9-28-H80	9W	28	100V-240V	830*280*285/4pcs	9.9
C-233SBLED9-28-H100	9W	28	100V-240V	1030*280*285/4pcs	13.8

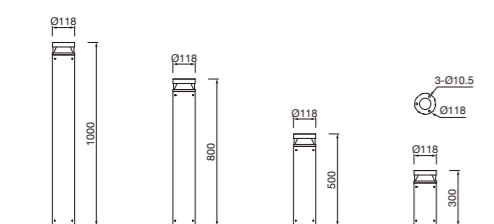

可选配件 Accessories options

	Code
Q-02H防水连接器 Terminal Box	320000698
基础预埋件 Anchor Bolts	250000377
膨胀螺钉 Expansion Bolts	613040003



C-233A

Code	Power	LED Qty	Input Voltage	Packing Size	Weight
LED chips - 2835					
C-233ALED25-80-H30	25W	80	100V-240V	210*210*330	4.9
C-233ALED25-80-H50	25W	80	100V-240V	210*210*530	6
C-233ALED25-80-H80	25W	80	100V-240V	210*210*830	7.7
C-233ALED25-80-H100	25W	80	100V-240V	210*210*1030	8.8



C-233B

Code	Power	LED Qty	Input Voltage	Packing Size	Weight
LED chips - 2835					
C-233BLED15-60-H30	15W	60	100V-240V	210*210*330	4.9
C-233BLED15-60-H50	15W	60	100V-240V	210*210*530	6
C-233BLED15-60-H80	15W	60	100V-240V	210*210*830	7.7
C-233BLED15-60-H100	15W	60	100V-240V	210*210*1030	8.8

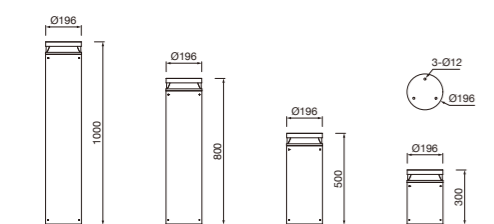

可选配件 Accessories options

	Code
Q-02H防水连接器 Terminal Box	320000698
基础预埋件 Anchor Bolts	250000627
膨胀螺钉 Expansion Bolts	613040003
基础锚 Anchor	250000379





C-234 Series



简述 Description

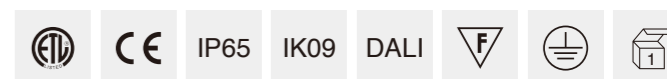

- 具有360° 的配光
- 铝压铸盖帽，铝合金拉伸灯体，可根据需要截取不同高度
- 高透明PC扩散罩，能有效防止发黄老化
- 灯具采用间接投射发光模式，具有很好的视觉舒适性
- 无生物蓝光危害风险，符合EN62471: 2008标准
- 防紫外线聚氨酯酯粉喷涂表面，耐腐蚀可以达1000小时以上
- 灯具表面最高温度不超过50度，安全可靠

- With 360° light distribution.
- Aluminum die casting cover, extruded aluminum body, it can be cut different height.
- High transparent PC diffuser, it can effectively prevent yellowing and aging.
- Indirect light luminaire for use with led, which has high visual comfortable.
- No photo-biological risk, (no risk linked to infrared, blue light and UV radiation) in accordance with EN 62471:2008.
- Surface anti-ultraviolet pure polyester powder painting.
- The maximum surface temperature of all accessible part under 50 degrees.



C-234A
25W

C-234B
25W

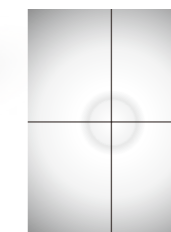

Light emission 360°

技术参数 Technology data

Code	Power	LED Qty	Input Voltage	Packing Size	Weight
LED chips - 2835					
C-234ALED25-80-H80	25W	80	100V-240V	830*195*200	7.1
C-234ALED25-80-H100	25W	80	100V-240V	1030*195*200	8.5
LED chips - 2835					
C-234BLED25-80-H80	25W	80	100V-240V	830*235*240	7.1
C-234BLED25-80-H100	25W	80	100V-240V	1030*235*240	8.5

可选配件 Accessories options

	Code
Q-02H防水连接器 Terminal Box	320000698
基础预埋件 Anchor Bolts	250000380
膨胀螺钉 Expansion Bolts	613040003
基础锚 Anchor	250000381

延伸产品 More in family

Solar version



CS-234

Solar Bollard Lighting: 4W.

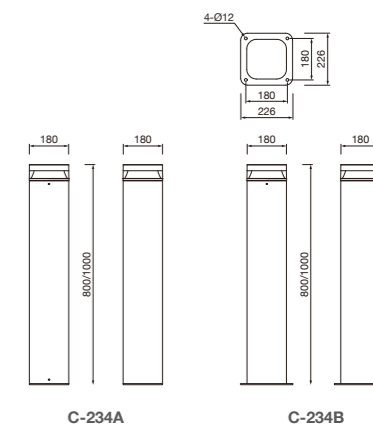



简述 Description

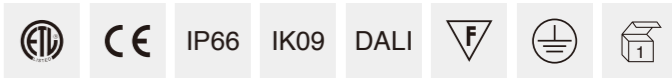

- 铝合金拉伸灯体，铝合金拉伸灯杆，模组式光源模块配超白钢化玻璃
 - 高透光PC透镜，具有高视觉舒适性和均匀配光，供多种不同配光选择
 - 高性能LED芯片，驱动有0-10V / DALI / 编程电源选择
 - 灯具采用LED模组，安装更换方便
 - 无生物蓝光危害风险，符合EN62471: 2008标准
 - 防紫外线聚氨酯喷塑表面，盐雾测试可达1000小时以上
 - 灯具表面最高温度不超过50度，安全可靠
- Aluminum alloy tensile lamp body, aluminum alloy tensile lamp pole, modular light source module with ultra-white tempered glass.
 - Optics with PC lens with high visual comfortable and uniform lighting distribution, multiple light distribution options.
 - High quality LED chips, Driver with 0-10V/DALI/programmed options.
 - LED module is used inside, which is easy to install and replace.
 - No photo-biological risk, (no risk linked to infrared, blue light and UV radiation) in accordance with EN 62471:2008.
 - Surface anti-ultraviolet pure polyester powder painting, Corrosion resistance can be more than 1000 hours.
 - The maximum surface temperature of all accessible part under 50 degrees.

其他功能选项: 应急功能 / 双色温切换功能
 Other Options: Emergency options / Colour temperature options

配光曲线 Photometric Data

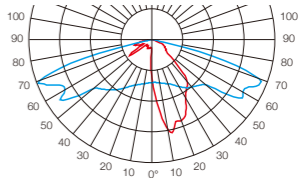

C-232S
12W

技术参数 Technology data

Code	Power	LED Qty	Input Voltage	Packing Size	Weight
LED chips - 3030					
C-232SLED12-14H80	12W	14	100V-240V	845*285*185	6.5
C-232SLED12-14H100	12W	14	100V-240V	1045*285*185	7.2

可选配件 Accessories options

	Code
Q-02H防水连接器 Terminal Box	320000698
基础预埋件 Anchor Bolts	250000688

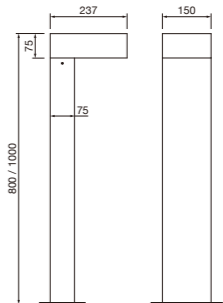

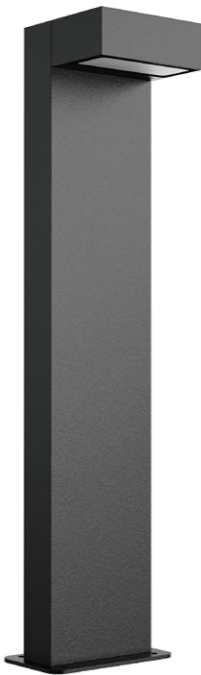

C-242
12W



C-242L
25W



C-242D
2*12W

简述 Description

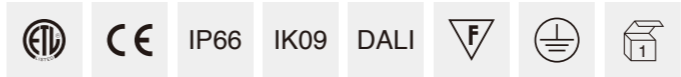

- 铝压铸盖帽，铝合金拉伸灯体，可根据需要截取不同高度
- 高透光PC透镜，具有高视觉舒适性和均匀配光，供多种不同配光选择
- 高性能LED芯片，驱动有0-10V / DALI / 编程电源选择
- 灯具采用LED模组，安装更换方便
- 无生物蓝光危害风险，符合EN62471: 2008 标准
- 防紫外线聚氨酯塑料喷涂表面，盐雾测试可以达1000小时以上
- 灯具表面最高温度不超过50度，安全可靠

其他功能选项:
双色温切换功能

- Aluminum die casting cover, extruded aluminum body, it can be cut different height.
- Optics with PC lens with high visual comfortable and uniform lighting distribution, multiple light distribution options.
- High quality LED chips, Driver with 0-10V/DALI/programmed options.
- LED module is used inside, which is easy to install and replace.
- No photo-biological risk, (no risk linked to infrared, blue light and UV radiation) in accordance with EN 62471:2008.
- Surface anti-ultraviolet pure polyester powder painting, Corrosion resistance can be more than 1000 hours.
- The maximum surface temperature of all accessible part under 50 degrees.

Other Options:
CCT option

技术参数 Technology data

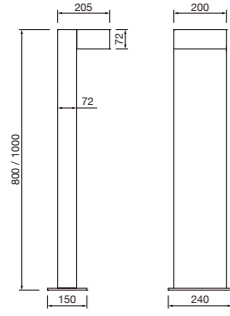

C-242

Code	Power	LED Qty	Input Voltage	Lumen	Packing Size	Weight
LED chips - 2835						
C-242LED12-72H80	12W	72	100V-240V	1500lm	830*235*260	6.5
C-242LED12-72H100	12W	72	100V-240V	1500lm	1030*235*260	7.2

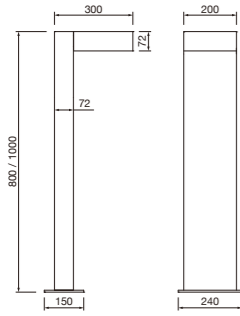

C-242L

Code	Power	LED Qty	Input Voltage	Lumen	Packing Size	Weight
LED chips - 3535/5050						
C-242LLED25-24H80	25W	24	100V-240V	3750lm	830*260*240	7.8
C-242LLED25-24H100	25W	24	100V-240V	3750lm	1030*260*240	8.2

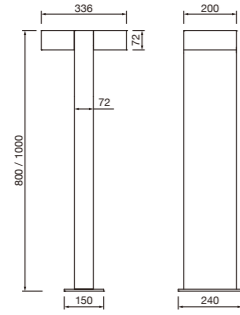

C-242D

Code	Power	LED Qty	Input Voltage	Lumen	Packing Size	Weight
LED chips - 2835						
C-242DLED24-144H80	2*12W	2*72	100V-240V	2*1500lm	830*310*260	9
C-242DLED24-144H100	2*12W	2*72	100V-240V	2*1500lm	1030*310*260	9.7

配光曲线 Photometric Data

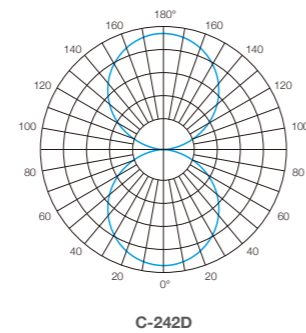
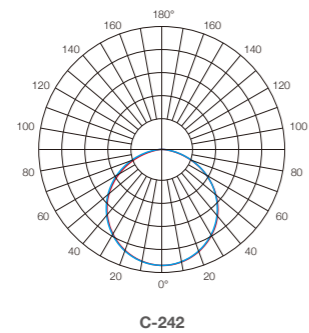

延伸产品 More in family



B-242

Wall Lighting: 12W.



B-242L

Wall Lighting: 25W.



B-242W

Wall Lighting: 12W.



CS-242

Solar Bollard Lighting: 10W. Without Flange Version.



C-242-B/C-242D-B

可选配件 Accessories options

	Code
Q-02H防水连接器 Terminal Box	320000698
基础预埋件 Anchor Bolts	250000688
膨胀螺钉 Expansion Bolts	613020003





简述 Description

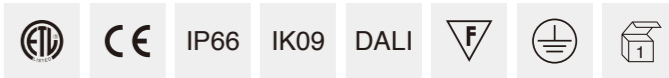

- 铝压铸盖帽，铝合金拉伸灯体，可根据需要截取不同高度
- 顶部光源搭配PC扩散板，具有很高视觉舒适性
- 高透光PC透镜，具有高视觉舒适性和均匀配光，供多种不同配光选择
- 无生物蓝光危害风险，符合EN62471: 2008标准
- 防紫外线聚氨酯塑粉喷涂表面，耐腐蚀可以达1000小时以上
- 灯具表面最高温度不超过50度，安全可靠

- Aluminum die casting cover, extruded aluminum body, it can be cut different height.
- Top light source with PC diffuser for high visual comfort.
- Optics with PC lens with high visual comfortable and uniform lighting distribution, multiple light distribution options.
- No photo-biological risk, (no risk linked to infrared, blue light and UV radiation) in accordance with EN 62471:2008.
- Surface anti-ultraviolet pure polyester powder painting.
- The maximum surface temperature of all accessible part under 50 degrees.



C-243
25W

配光曲线 Photometric Data

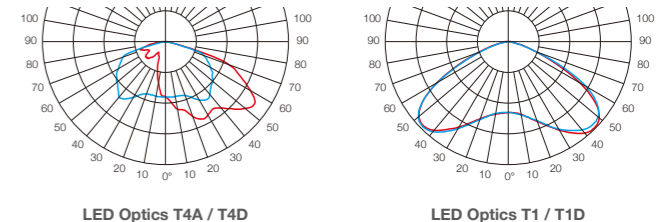

技术参数 Technology data

Code	Power	LED Qty	Input Voltage	Packing Size	Weight
LED chips - 5050					
C-243LED25-16H100	25W	16	100V-240V	1030*295*295	12
C-243LED25-16H120	25W	16	100V-240V	1230*295*295	13.5

可选配件 Accessories options

	Code
Q-02H防水连接器 Terminal Box	320000698
基础预埋件 Anchor Bolts	250000801
膨胀螺钉 Expansion Bolts	613040003
基础锚 Anchor	250000381

延伸产品 More in family

Solar version



CS-243
Solar Bollard Lighting: 10W.

